



LAGOON



User's guide



46

WELCOME ABOARD

We share a common passion for the sea; we, LAGOON, as catamaran builders and you who want to live your passion on the seven seas.

We are delighted to welcome you to the family of LAGOON catamaran owners and we congratulate you on it.

This instruction guide is intended to help you to enjoy your boat in comfort and safety.

It includes the boat specifications, the equipment provided or installed, the systems on board and tips on their use and maintenance.

We advise you to read this guide carefully before setting sail in order to take the greatest advantage of your sailing.

Our network of LAGOON official retailers is entirely at your disposal in order to help you discovering your boat. They will be the most able to do the maintenance on your boat.



REJOIGNEZ LE CLUB LAGOON ! JOIN THE CLUB LAGOON!

Vous venez d'acquérir un catamaran Lagoon! Saviez-vous qu'un club de propriétaires existait? En tant que propriétaire Lagoon, vous bénéficiez d'un accès exclusif à ce club.

POURQUOI LE CLUB LAGOON ?

Il s'inscrit dans la logique de la *Lagoon Attitude* qui nous est chère : entretenir des relations simples et amicales avec nos clients, leur proposer des rendez-vous privilégiés, aller à leur rencontre. Avec le *Club Lagoon*, nous voulons concrétiser cet état d'esprit en vous faisant bénéficier de certains avantages.

QUELS AVANTAGES POUR LES MEMBRES DU CLUB LAGOON ?

En tant que membre du *Club Lagoon*, vous avez accès au site privé www.club-lagoon.fr : des informations sur le chantier, nos catamarans et nos événements, des fiches techniques, des invitations aux salons nautiques, une boutique privée, et des offres exclusives de nos partenaires (à voir sur le site !).

L'adhésion au *Club Lagoon* est simple et gratuite. Nous serons très heureux de vous y accueillir, alors n'hésitez plus, rendez-vous sur notre site pour vous inscrire.

You have just purchased a Lagoon catamaran! Did you know that an owner club exists? As Lagoon owner, you get an exclusive access to this club.

WHY JOIN CLUB LAGOON?

The Club reflects the *Lagoon Attitude* that we value so highly: in other words, our desire to develop warm, open relations with our customers, organise special events for you and meet you in person. With *Club Lagoon*, we wish to follow through with this way of thinking by giving you access to some specific benefits.

WHAT BENEFITS DO CLUB LAGOON MEMBERS ENJOY?

As a member of *Club Lagoon*, you can access the private website www.club-lagoon.fr: here you will find exclusive information about the shipyard, our catamarans and our events, technical documents, invitations to boat shows, an exclusive boutique and special offers from our partners (you can see them on the website).

***Club Lagoon* membership is free and it couldn't be simpler to join. We look forward to welcoming you to the Club, so go to our website to register.**



www.club-lagoon.fr

Club
Lagoon

PREAMBLE

■ This user guide is a tool that will enable you to get to know your boat and apprehend the use of the components that are necessary for running her. Some of the equipments mentioned in this guide are optional fittings.

■ A WAY TO MAKE THE MOST OF THIS USER GUIDE

In order to have an easier apprehension, this guide offers you two complementary reading levels:

- . The pages with text on the right hand side of the document develop the different subjects dealt with in the chapters,
- . The pages on the left hand side are given to the related photos, layouts or block diagrams.

■ The different warnings used throughout this guide are as follows:

RECOMMENDATION

Shows a piece of advice to do the appropriate actions or manoeuvres adapted to what you are thinking of doing.

WARNING

Draws your attention on dangerous ways of doing that may bring about injuries to people or damages to the boat or her components.

DANGER

Warns you about the existence of a hazard that may have serious or fatal consequences if the appropriate precautions are not taken.

■ Before you put out to sea, please read the owner's manual (CE standard manual) delivered with your boat and please follow the instructions.

CONTENTS

1. SPECIFICATIONS PAGE 7	5. UTILITY ABOARD..... PAGE 49	9. WINTER STORAGE..... PAGE 93
1.1 I D of your boat	5.1 Refrigerators - Icebox - Icemaker	9.1 Laying up
1.2 Technical specifications	5.2 Microwave oven	9.2 Protection
1.3 Helm station	5.3 Oven, hotplates	
1.4 Electrical panel	5.4 Television	
	5.5 Dishwasher	
2. HULL / DECK PAGE 15	5.6 Air conditioning	
2.1 Construction	5.7 Heating	
2.2 Careening		
2.3 Deck equipment	6. WATER SYSTEMS PAGE 59	
2.4 Cockpit	6.1 Bilge pump system	
2.5 Access to the fly	6.2 Grey waters	
2.6 Gangway	6.3 Black waters	
2.7 Steering system	6.4 Fresh water	
2.8 Anchoring	6.5 Watermaker	
2.9 Deckwash pump		
2.10 Davit	7. ELECTRICITY PAGE 71	
2.11 Tenderlift	7.1 12 V circuit	
	7.2 Inverter	
3. RIGGING / SAILS PAGE 29	7.3 Solar panels	
3.1 Sailing	7.4 110 V - 220 V circuit	
3.2 Standing rigging	7.5 Electronics	
3.3 Running rigging		
3.4 Sails		
	8. MOTORIZATION..... PAGE 85	
4. ACCOMMODATIONS..... PAGE 43	8.1 Engines	
4.1 Saloon - Galley	8.2 Fuel	
4.2 Lighting	8.3 Propellers - Anodes	
4.3 Portholes - Deck hatches	8.4 Dash board	
4.4 Curtains - Window blinds		
4.5 Sliding window in the roof		
		10. HANDLING PAGE 97
		10.1 Preparation
		10.2 Crane lifting
		10.3 Mast stepping - Mast unstepping
		11. SAFETY PAGE 101
		11.1 Prevention
		11.2 Gas system
		11.3 Fire
		11.4 Bilge pump system
		11.5 Safety equipment
		11.6 General remarks
		12. MAINTENANCE..... PAGE 113
		12.1 Maintenance schedule

SPECIFICATIONS

1

- 1.1 I D of your boat**
- 1.2 Technical specifications**
- 1.3 Helm station**
- 1.4 Electrical panel**

YOUR BOAT

NAME OF YOUR BOAT:

VERSION:

DELIVERY DATE:

REGISTRATION NUMBER:

DOOR KEY NUMBER:

HULL NUMBER:

MAKE OF THE ENGINES:

NUMBERS OF THE ENGINE KEYS:

SERIAL NUMBER OF THE STARBOARD ENGINE:

SERIAL NUMBER OF THE PORT ENGINE:

FURTHER INFORMATION:

.....

.....

.....

OWNER'S NAME:

ADDRESS:

.....

.....

E-MAIL ADDRESS:

LANDLINE PHONE NUMBER:

MOBILE PHONE NUMBER:

EMERGENCY CONTACT

1



LAGOON

www.cata-lagoon.com

162, quai de Brazza - 33100 Bordeaux - France • Tel. 33 (0) 557 80 92 80 • Fax 33 (0) 557 80 92 81 • E-mail : info@cata-lagoon.com

DESIGN CATEGORIES

CATEGORIES	MAXIMUM WIND			MAXIMUM WAVES
Category A	Force 9	Established 47 knots	Gusts approximately 61 knots	10 metres
Category B	Force 8	Established 40 knots	Gusts approximately 52 knots	8 metres
Category C	Force 6	Established 27 knots	Gusts approximately 35 knots	4 metres
Category D	Force 4	Established 16 knots	Gusts approximately 23 knots	0,5 metre

The maximum height of waves is measured from trough to crest; The European regulations use the concept of significant height of waves ($H_{1/3}$).

The wind force (Beaufort scale) is the average actual wind speed over a period of 10 minutes at 10 metres above the sea.

TECHNICAL SPECIFICATIONS

Length Over All.....	13,99 m / 45'8"
Waterline length	13,87 m / 45'6"
Beam.....	7,96 m / 26'1"
Air draft.....	23,21 m / 76'2"
Keel draft.....	1,35 m / 4'5"
Light displacement	16313 kg
Maximum load displacement (cat. A).....	23343 kg
Maximum load displacement (cat. B).....	23343 kg
Maximum load displacement (cat. C).....	23733 kg
Maximum load displacement (cat. D).....	24483 kg
Maximum load (cat. A).....	7030 kg
Maximum load (cat. B).....	7030 kg
Maximum load (cat. C).....	7420 kg
Maximum load (cat. D)	8170 kg
Water capacity.....	2 x 300 l
Fuel capacity	2 x 520 l
Cold capacity.....	130 l (standard) + 144 l (pack essential)
.....	ou 110 l + 155 l (optional)
Engine power	2 x 45 CV

BATTERY CAPACITY

Standard.....	3 x 140 Ah (12 V)
Optional.....	3 x 140 Ah (12 V)
Engines	2 x 110 Ah (12 V)
Generator	110 Ah (12 V)

CE CATEGORY	Maximum number of persons
A.....	12 persons
B	14 persons
C	20 persons
D	30 persons



Bottom surface: approx. 70 m²



SPECIFICATIONS

11

HELM STATION

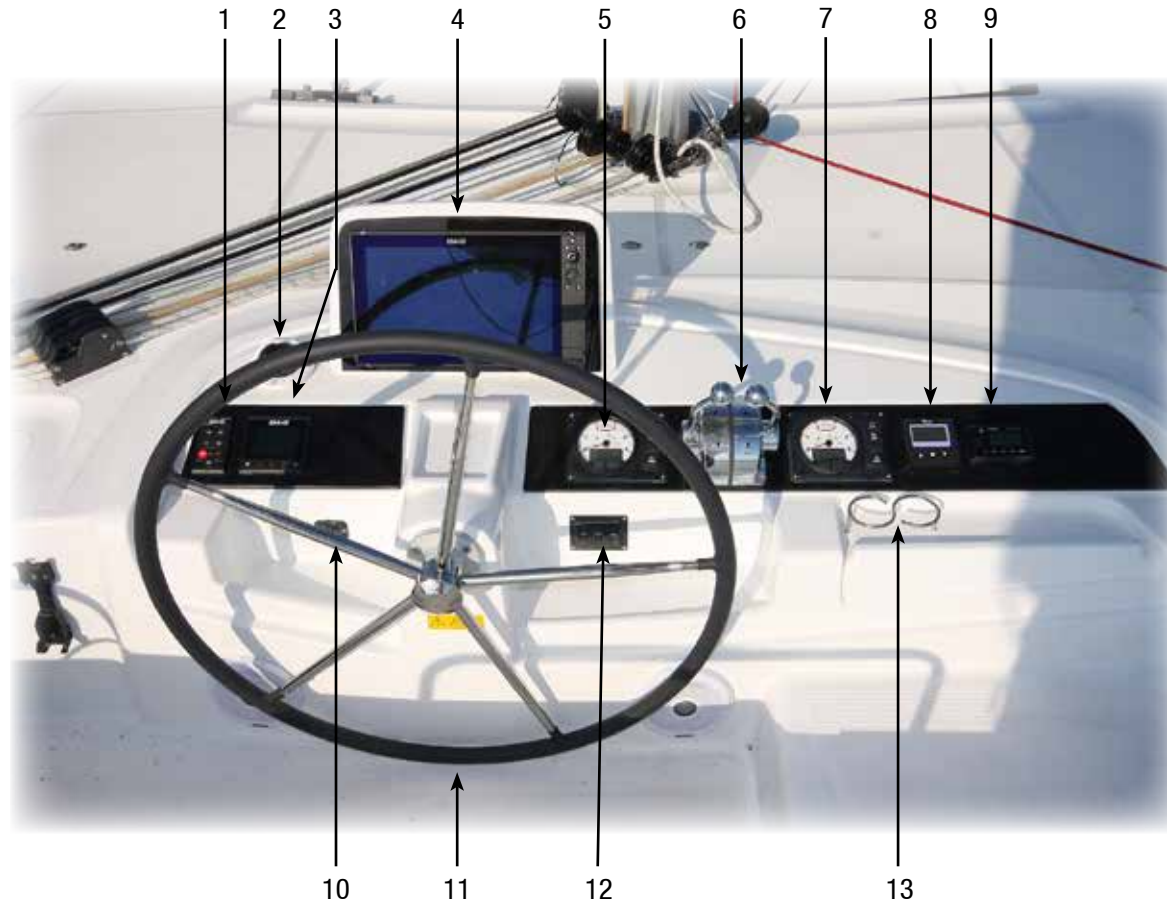

SPECIFICATIONS

12

1 - Automatic pilot control (optional).

2 - Compass.

3 - Screen / repeater for electronic (optional).

4 - Screen / repeater for electronic (optional).

5 - Port engine panel.

6 - Engines controls.

7 - Starboard engine panel.

8 - Windlass control + chain counter
(depending on finish).

9 - Radio / Hifi control.

10 - 12 V socket.

11 - Steering wheel.

12 - Bilge pump switches
+ underwater lights (optional).

13 - Cup holder.

ELECTRICAL PANELS

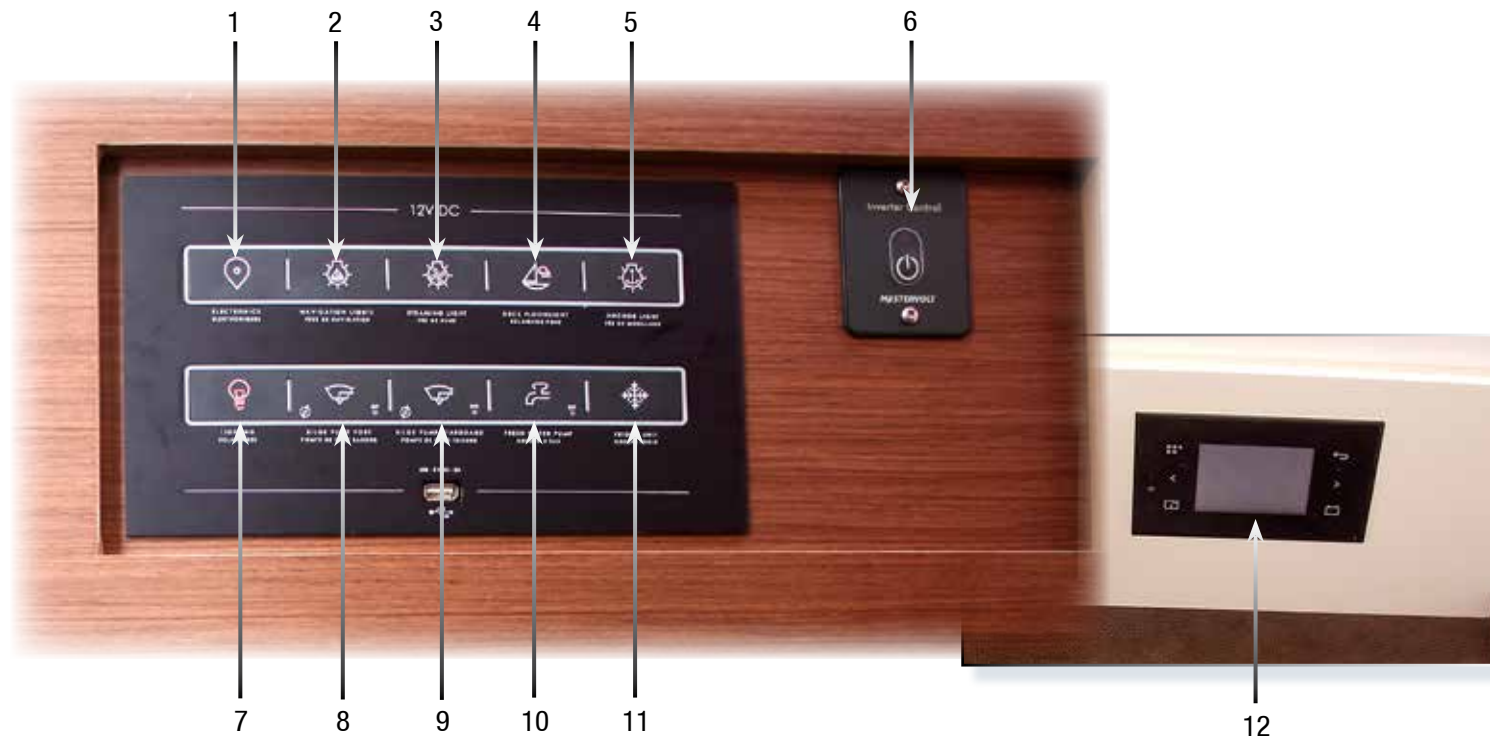

- 1 - Electronics.
- 2 - Navigation lights.
- 3 - Steaming lights.
- 4 - Deck searchlight.
- 5 - Mooring light.
- 6 - 12 V / 220 V - 2000 Va inverter control (optional).

- 7 - Internal lighting.
- 8 - Port bilge pump
- 9 - Starboard bilge pump.
- 10 - Water pump.
- 11 - Refrigerated unit.

- 12 - Control touch screen

Screen used to:

- check the levels of charge and voltage in the battery banks, as well as the gauges for the freshwater and fuel tanks.
- control the boat's 220 V power supplies (generator and shore socket).
- switch the generator on and off.

1

SPECIFICATIONS

13

HULL / DECK

2

- 2.1 Construction**
- 2.2 Careening**
- 2.3 Deck equipment**
- 2.4 Cockpit**
- 2.5 Access to the fly**
- 2.6 Gangway**
- 2.7 Steering system**
- 2.8 Anchoring**
- 2.9 Deckwash pump**
- 2.10 Davit**
- 2.11 Tenderlift**

HULL PROTECTION

PROTECTIVE FENDERS



HULL / DECK

16

■ 2.1 Construction

The LAGOON 46 is constructed following the infusion process of a polyester resin and a high quality anti-osmotic resin on a core of balsa and fibreglass layers.

WARNING

Do not let the hull's large plexiglass windscreens come into contact with fenders or hawsers: surface damage would be irreparable.

■ 2.2 Careening

A periodical careening of your boat will keep her original performances and avoid any adhesion of marine vegetation.

The type of the water where you boat sails determines how to choose the antifouling paint as well as how often to carry out these careenings.

Please contact a professional for advice.

■ 2.3 Deck equipment

• DECK FITTINGS

The fittings on the deck of your LAGOON 46 were selected according to quality criteria.

To keep them to their best look, a regular maintenance is necessary.

- Rinse the equipments with fresh water, particularly the stainless steel parts.
- Lubricate the different blocks, sheaves, turnbuckles, winches, tracks and travellers.
- Clean and polish the stainless steel parts with a chrome and stainless steel polish in case of oxidation.

• PULPITS

Regularly rinse the stainless steel parts with fresh water.

• LIFELINES

Inspect the metal lifelines for 'hairy wires'.

Check for corrosion, in particular on the connections.

• OUTSIDE WOODWORK

Regularly rinse and brush the outside woodwork with fresh water.

There are teak cleaners and brighteners on sale.

The use of a pressure washer is not advisable on teak.

DECK EQUIPMENT

**ENTRANCE DOOR INTERNAL
BRAKE SYSTEM**



**UNLOCKING THE SLIDING
BENCH SEAT**



OPENING SERVING HATCH



SWIM LADDER IN TRANSOM

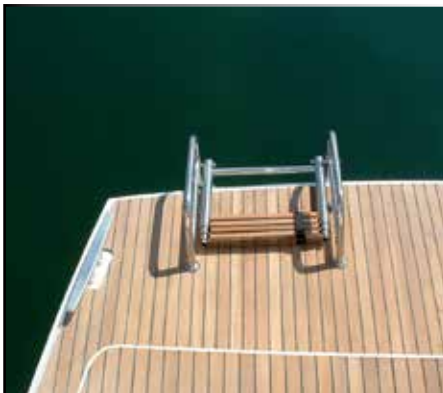

SHOWER IN TRANSOM



ACCESS TO THE FLY



- PLEXIGLAS

To protect the surface of your windows in plexiglas, avoid any contact with alcohols, tanning creams, sand and all abrasive products generally speaking.

- Rinse the plexiglas with fresh water, do not use solvents.
- Brighten up with a soft rag soaked with a gentle cleaning product.
- Use polish paste to remove scratches.

■ 2.4 Cockpit

- ACCESS DOOR

The sliding door is fitted with a mechanism allowing its locking in an open position. A latch on the door jamb allows its locking from inside the saloon.

RECOMMENDATION

While sailing, block the sliding door locking it.

- SERVING HATCH

The cockpit is fitted with an opening serving hatch.

While sailing, please lock the serving hatch either in the open or closed position.

- SLIDING COCKPIT BENCH SEAT

The cockpit can be fitted with a sliding bench seat (option).

Press the button on the side to unlock the bench seat and slide it along its guide rail.

- SWIM LADDER

A stainless steel swimming ladder is located on the port transom.

The boat may optionally be fitted with a second swimming ladder (with the option of a second hand shower in the cockpit).

WARNING

For safety's sake, always sail with the ladder up and kept in position.

- SHOWER

According to the lay out, a shower supplied with hot and cold water is located on the port transom.

A second shower can be optionally installed on the starboard transom (with second swimming ladder).

■ 2.5 Access to the fly

Two staircases - one to port, the other to starboard - enable access to the flying bridge from the cockpit.

During sailing, watch out for possible movements of the boat when using these staircases.

STROP - ELECTRIC WINDLASS

HULL / DECK

20

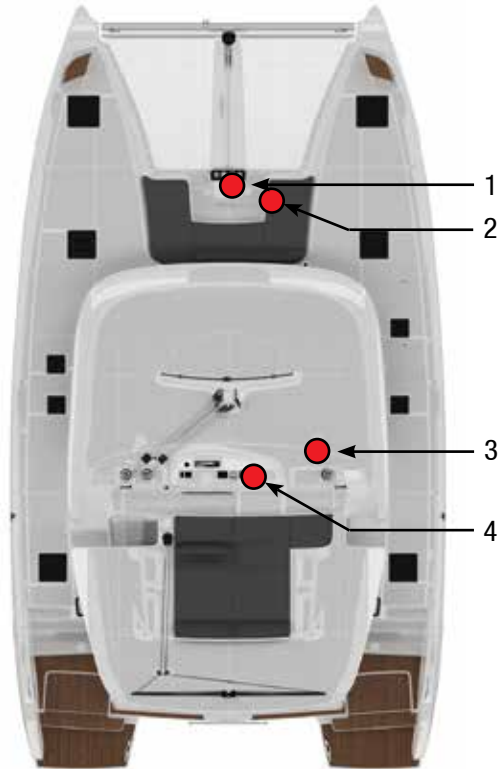

- 1 - Electric windlass.
- 2 - Electric windlass control.
- 3 - Windlass automatic breaker.
- 4 - Windlass control + chain counter (optional).

STROP CIRCUIT



ELECTRIC WINDLASS



CONTROL OF THE WINDLASS + CHAIN COUNTER



WINDLASS AUTOMATIC BREAKER



■ 2.6 Gangway (optional)

The boat may optionally be fitted with a foldable carbon gangway. Remove, store and stow the gangway when sailing.

WARNING

Do not use the gangway as a diving board.

■ 2.7 Steering system

The steering system is made up of steering cables (stainless steel cables) and two aluminium quadrants.

You can reach it through the engine compartments both starboard and port sides.

The suspended rudders are fitted with stainless steel stocks.

Only WD 40 should be used to maintain nylon, ertalon or teflon bushings.

Please refer to Chapter 'SAFETY' as for the emergency tiller use.

■ 2.8 Anchoring

• WINDLASS

The electric windlass works with the 12 V domestic batteries.

The windlass is operated using the controls located in the starboard locker on the forward deck or those located in the chain counter box (optional) in the helm station.

If the electrical windlass does not function properly, check its circuit breaker located in the passageway locker facing the aft starboard cabin.

For the maintenance of the windlass, please refer to the manufacturer's guide.

RECOMMENDATION

Use the electric windlass when one or two engines are operating.

• PREPARING ANCHORING

Set the strop fastening it to the chainplates at the ends of the main beam.

Insert the strop inside the stem anchor roller.

Make fast the strop to the central cleat when lowering the chain.

RECOMMENDATION

Before you anchor, check the type of the sea bed, the depth of water and the strength of the stream.

DECKWASH PUMP

HULL / DECK

22



Please note: you can find the same locations in the other accommodation version.

VALVE TO SELECT SEA WATER / FRESH WATER + SWITCH

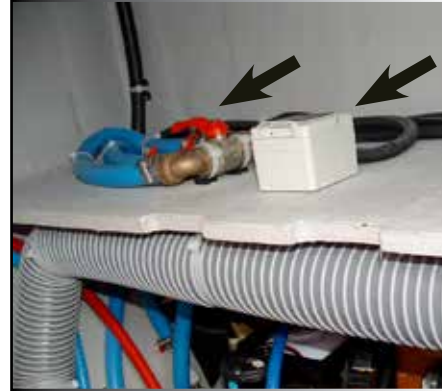

DECKWASH PUMP



INTAKE TO CONNECT HOSE



- 1 - Valve to select sea water / fresh water.
- 2 - Power switch.
- 3 - Deckwash pump.
- 4 - Intake to connect hose.
- 5 - Sea water valve.

- ANCHORING

Have your boat head wind and without speed.
Pay out the chain while moving back slowly.
Secure the chain on the strop.
Release the chain until the strop is taut.
Pay attention to the swinging space when mooring.

- LIFTING THE ANCHOR

Ensure that the chain is properly set on the gypsy.
Activate the windlass in the upward position.
Slowly go near the anchor using the engine (do not use the windlass force to winch up the boat).
Visually check the final metres until the anchor makes contact with the anchor roller.
Check the position of the anchor on the stemhead fitting.

Rinse the windlass and the ground tackle with fresh water after each trip.

In case of electric failure, use the winch handle on the windlass to raise the ground tackle.

Refer to the manufacturer's instructions for windlass maintenance.

Nota: the boat may be optionally fitted with a chain counter in the helm station.

The chainmeter box has a fitted windlass control.

The standard measurement "Zero" corresponds to the position of the anchor ready to be dropped.

Refer to instructions for its use and maintenance.

WARNING

Windlass operations are dangerous:

- Always keep the ground tackle clear and free.
- Always proceed with care, wearing gloves and always wearing shoes.
- Make sure that nobody leans on the windlass when operating the control.

■ 2.9 Deckwash pump (optional)

The deck wash pump is located in the port engine compartment. It provides sea water or fresh water from tanks.

The fresh or sea water selector valve is located in the port engine compartment.

The seawater inlet valve is located at the bottom of the port engine compartment.

Turn on the deck wash pump using its switch located in the port engine compartment.

DAVIT

HULL / DECK

24



DAVIT



LINE DRIVER



- 1 - Davit automatic breaker.
- 2 - Line driver (option).
- 3 - Line driver control.
- 4 - Davit.

DAVIT AUTOMATIC BREAKER



■ 2.10 Davit (optional)

Depending on its fitting out, the boat may have a davit system with a dedicated manual winch.

It may also have a system with an electric winch (option).

WARNING

The davits are designed to support a maximum load of 200 kg and a tender which is maximum 3,60 metres long.

• INSTALLING A TENDER ONTO THE DAVIT

After having taken away everything from the tender:

- Lower the davit system as close as possible to the tender.
- Fix the tackle hooks located on the davit to the fore and aft of the tender.
- Close the blocker located on the port side of the davit system.
- Raise the davit and tender using the manual or electric winch (option).
- Once in the top position, secure the davit system and tender using the appropriate ropes.
- Remove the water drain plug from the tender.

• LAUNCHING A TENDER FROM THE DAVIT

Put the water drain plug back into position in the tender.

- Check that the jammer located on the davit is locked.
- Run the davit pennant around the winch (spin at least three times around it).

After having removed the hold safety devices and moored the tender:

- Open the blocker and let the line run until the tender reaches the water.

- Cast off the tackle hooks on the davit to the fore and aft of the tender.
- Remount and secure the davit system.

WARNING

Nobody should be on board or under the tender during manoeuvres carried out with the davit. Tie up the tender during manoeuvres.

When sailing, remove the tender engine and store it on board.

Moor the tender considering the sea state and the route.

Put in the tender the security equipment in conformity with the registration country of the boat.

TENDERLIFT

HULL / DECK

26



TENDERLIFT HYDRAULIC PUMP



TENDERLIFT FOLDING PANELS



■ 2.11 Tenderlift (option)

The boat may optionally be fitted with a hydraulic tenderlift. It is automatically switched on when the on board general battery cut-out switch is ON.

WARNING

The tenderlift is designed to withstand a maximum load of 250 kg and a tender of a maximum length of 3.40 metres.

In case of malfunctioning, check the fuse in the starboard engine compartment.

The tenderlift has two panels that when folded act as cradles for the tender and once deployed expand the reception area.

Lock unfolded panels using their bolt.

Lock folded panels using their strap.

When sailing, stow the tender on the cradles and secure the folded panels with straps.

WARNING

Make sure that no one is on the tenderlift when in operation.

When not in operation, the tenderlift must be locked in the high position using the turnbuckles.

RIGGING / SAILS

3

- 3.1 Sailing**
- 3.2 Standing rigging**
- 3.3 Running rigging**
- 3.4 Sails**

RIGHTING MOMENT

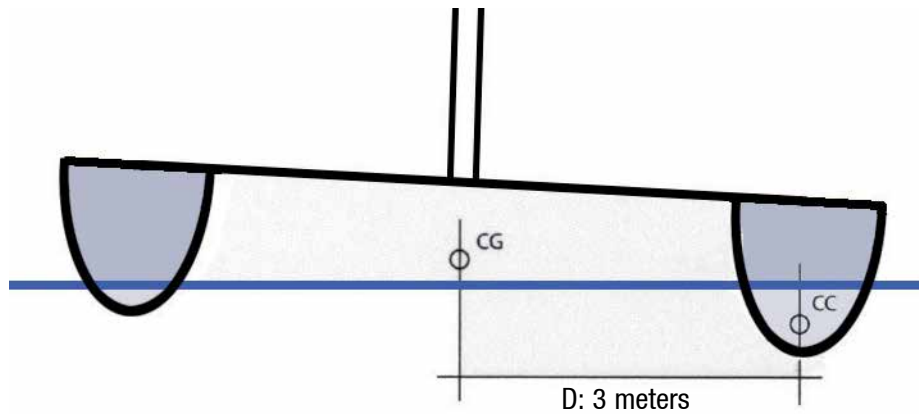

CATAMARAN
Weight of the boat: 10 tons

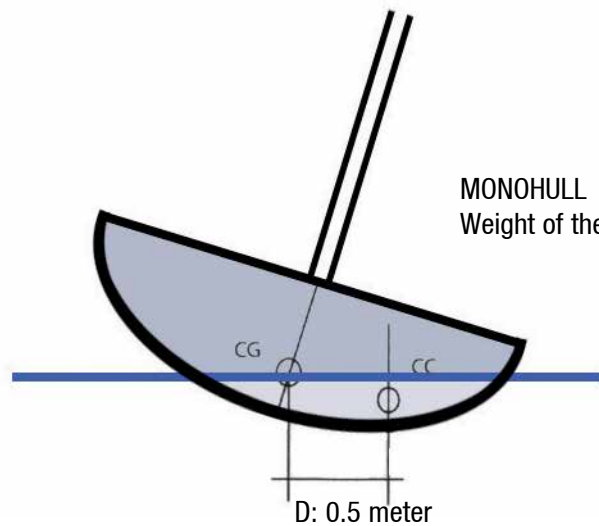

MONOHULL
Weight of the boat: 10 tons

Illustration of the difference of the righting moment existing between a 10 m monohull and catamaran.

d: distance between centre of the bottom and centre of gravity.

RMmax: Weight of the boat x d
(RMmax: moment of maximum uprighting)

RMmax monohull : 10 tons x 0.5 meter
: **5 tons.meters**

RMmax catamaran : 10 tons x 3 meters
: **30 tons.meters**

■ 3.1 Sailing

- BEWARE

A catamaran is about 6 times more resistant to heeling than a monohull.

In naval architecture, it is referred to as uprighting moment multiplication of the weight of the boat by the transversal distance between the centre of gravity and the centre of flotation (or bottom). See the illustration on the opposite page.

This fact has real consequences as for the sailing and sail trimming of a catamaran.

The fact that the boat does not heel may mask overcanvassing, which may be very dangerous for the crew and the boat. Therefore you must permanently keep a close eye on the speed of the true wind, and trim the sail surface according to the latter as a matter of priority.

The below-mentioned trims apply in a calm sea. When the sea is brown, you shall reduce earlier by 10% as far as the speed of true wind is concerned. And as a general rule, it is absolutely imperative to permanently try to ease up the boat rather than to stress her.

You will always try to have the forward edges of the sails facing the apparent wind, and to have the sail not sheeted home, so that the airflow behind the sail may be laminar, that is to say so that it may go off the aft part of the sail without any disruption.

In case you shouldn't follow the recommendations below, it might be dangerous for the boat and the crew, and, in case of an accident, the manufacturer's responsibility would not be involved.

- TRIMMING WHEN CLOSE HAULED (between 75 and 50° of true wind)

Wind force given in apparent wind

- **From 0 to 16 knots:** full sail; sheet traveller 30 cm above the centre line of the boat, mainsail sheeted with a slightly open leech (boom on the centre line of the boat).

The jib is trimmed so that it skims the spreader, the jib traveller is set so that the angle of the jib sheet is the continuation of a straight line that goes through the sheet clew and the luff, at 40% of its height.

- **From 16 to 20 knots:** full sail; the sheet traveller goes up 60 cm above the centre line of the boat, mainsail sheeted with a leech a little more open (boom always in line: therefore you must ease off the sheet). The jib traveller remains at the same place but the sheet is adjusted so that the leech is 10 cm far from the spreader.

- **From 20 to 26 knots:** 1 reef, full jib; the sheet traveller goes back to 30 cm above the centre line of the boat.

The jib traveller remains at the same place but the sheet is eased off so that the leech is 20 cm far from the spreader.

- **From 26 to 30 knots:** 1 reef, 75% of the jib; the sheet traveller goes up 60 cm above the centre line of the boat.

The jib traveller remains at the same place or slightly goes forward but it is adjusted so that the leech makes a propeller shape where the upper part let some air go off in increases of wind.

- **From 30 to 36 knots:** 2 reefs, 60% of the jib; the sheet traveller is back 30 cm above the centre line of the boat, the sheet is 50 cm eased off and the boom is leeward.

SAILS



■ Sails

Fully battened mainsail.....	76,5 m ² / 823 sq.ft
Square top mainsail (optional)	80,5 m ² / 866 sq.ft
Self-tacking jib	46,5 m ² / 500 sq.ft
Code 0 (optional)	105 m ² / 1130 sq.ft

I.....	17,840 m / 58'06"
J	6,650 m / 21'10"
P.....	17,550 m / 57'07"
E.....	6,170 m / 20'23"

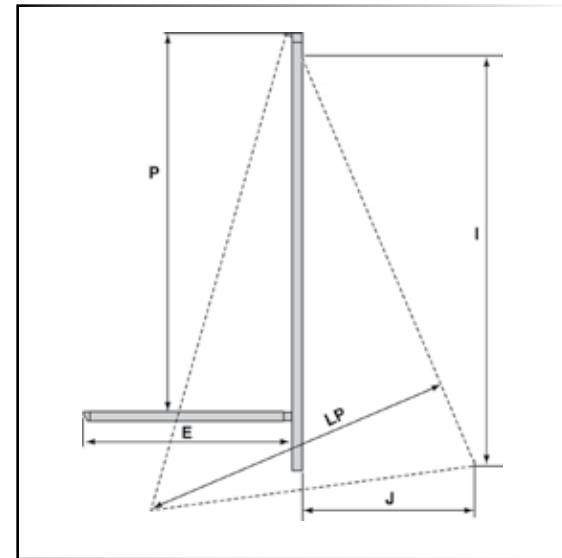

- **From 36 to 45 knots:** 2 reefs, jib 40%. The sheet traveller is on the centre line of the boat, the sheet is 1 metre eased off and the boom is leeward.

The jib traveller goes slightly forward, the sheet is eased off in order to open wide in gusts.

- **From 45 to 55 knots:** 2 reefs only (or try sail, or lying to), the traveller is on the centre line of the boat, the sheet is 1 metre eased off and the boom is leeward.

The boat would be more at ease scudding in such a weather.

- **Over 55 knots:** lying to, sea anchor, or preferably scudding.

- TRIMMING WHEN DOWN WIND (between 75 and 130° of true wind)

- **From 0 to 23 knots:** full sail; the traveller can be set at different places ranging from 1 metre off the centre line of the boat to the end of the track, depending on the angle of the wind, the sheet is eased off so that the boom may be leeward and 50 cm far from the traveller in dead calm then up to 2 metres when the wind strengthens.

In all the cases, you will avoid having more than one batten chafing against the upper shroud, in the fairest points of saling.

The jib is eased off in order to have its average front edge facing the apparent wind.

- **From 23 to 28 knots:** 1 reef, full jib. The trimmings are similar.

- **From 28 to 33 knots:** 2 reefs, 80% of the jib. The trimmings remain similar.

- **From 33 to 38 knots:** 2 reefs, 60% of the jib. The trimmings remain similar.

- **From 38 to 45 knots:** 2 reefs (or mainsail lowered and slightly more jib), jib 40%. The trimmings remain similar.

- **From 45 to 55 knots:** mainsail lowered, jib 40 to 30% quite hardened in order to avoid flapping.

- **Over 55 knots:** scudding, depending on the sea, you will set mooring ropes from one transom extension to the other one in order to reduce the speed of the boat.

These figures are given for reference only and are to be adapted regarding external conditions.

WARNING

If there is a radar aerial on the mast, keep an eye on the jib when you put about or gybe in order to avoid any risk of damage.

- GRAND-VOILE A CORNE

WARNING

A cruising square top mainsail is more powerful than a standard mainsail. Shorten the sails earlier, depending on the wind conditions.

RUNNING RIGGING - JIB CIRCUIT

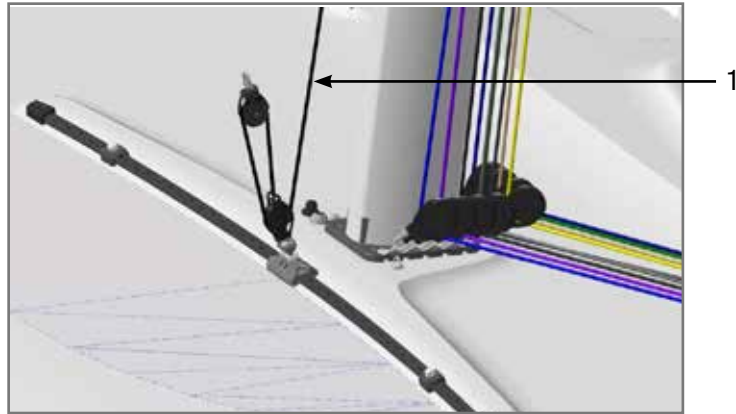

- 1 - Jib sheet.
- 2 - Jib halyard.
- 3 - Jib furling line.

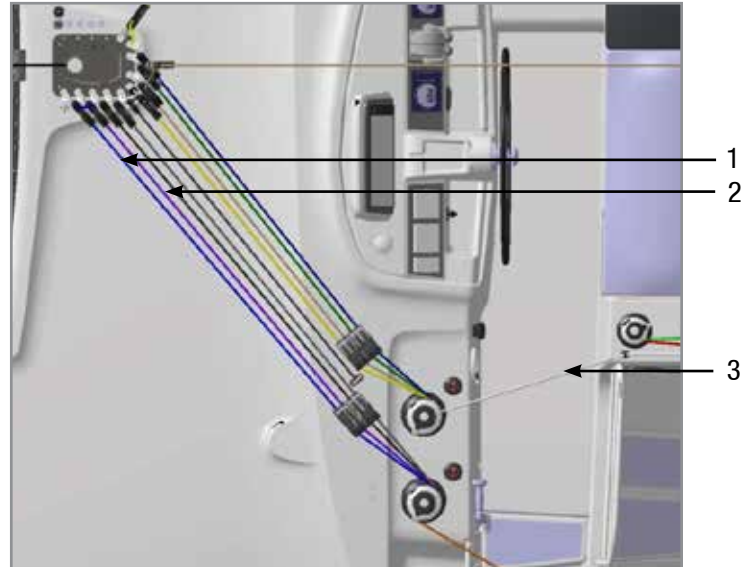

RIGGING / SAILS

34

■ 3.2 Standing rigging

The LAGOON 46 has been adjusted by the preparer or the mast manufacturer when first masting.

The cables stretch a little during the first sailings. Therefore it is advisable to have the mast inspected and adjusted by a specialist.

Before you put out to sea, it is essential to make sure that the standing rigging is in good condition: inspect the turnbuckles and check the condition of the shrouds.

RECOMMENDATION

Any intervention on the standing rigging comes within a specialist remit.

To hoist a crew member up to the top of the mast, use the topping lift. Belay the crew member with a bowline on the bosun's chair ring (do not use snap shackle or shackle).

Description of the ropes	length (m)	diametre (mm)
Jib halyard	55	12
Jib sheet	40 x 2	12
Mainsail halyard	70	12
Mainsail topping lift	46	12
Mainsheet	34	14
Mainsail traveller adjustment	19 x 2	10
Reef 1	32	14
Reef 2	40	14
Reef 3	53	14
Spinnaker / Code 0 sheet (optional)	29	14
Spinnaker / Code 0 halyard (optional)	75	10
Adjusting the Line driver mainsail traveller	21,5	10
Mainsail outhaul	25	6

RUNNING RIGGING - MAST BASE

RIGGING / SAILS

36

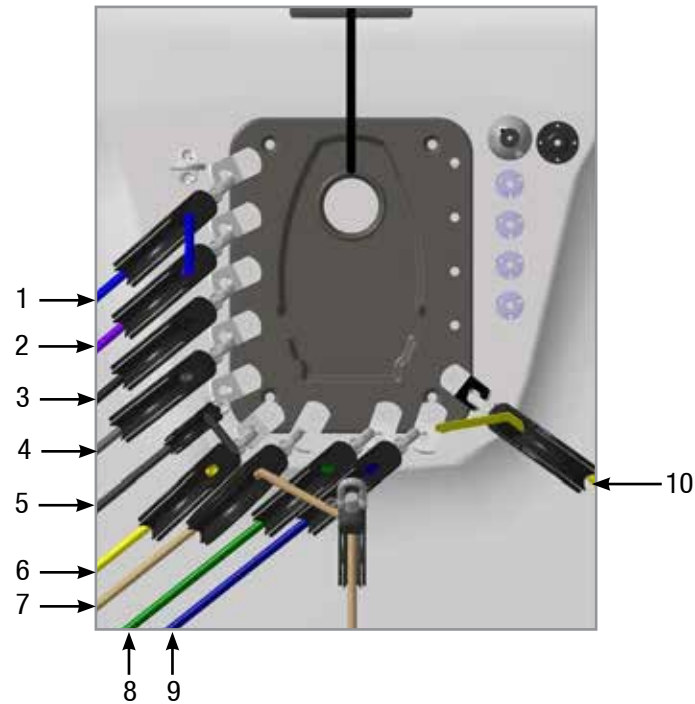

- | | |
|----------------------------|---------------------------------|
| 1 - Jib sheet. | 6 - Reef 1. |
| 2 - Jib halyard. | 7 - Mainsail sheet. |
| 3 - Mainsail halyard. | 8 - Reef 2. |
| 4 - Boom topping lift. | 9 - Reef 3. |
| 5 - Lowering the mainsail. | 10 - Code 0 halyard (optional). |

ELECTRIC WINCH BREAKER



■ 3.3 Running rigging

The mainsail and jib sheets, the topping lift, the reefing lines, the mainsail and spinnaker halyards, the control lines for the main traveller are led back to the manoeuvre station.

- SHEET WINCHES AND MANOEUVRE WINCHES (MANUAL OR ELECTRIC) (OPTIONAL EXTRA)

The circuit breakers for the electric winches are located in the passageway locker facing the aft starboard cabin.

RECOMMENDATION

Have at least 3 turns on the winch. Electrical winches generate an extremely powerful force and you should use them with much care. Never force when you find a jamming point. When using the winches, keep your hands away.

WARNING

Refer to the manufacturer's instructions to remove the winches and put them back. Improper refitting may result in accidents (for example: kick of the crank handle).

■ 3.4 Sails

- STANDARD MAINSAIL

To hoist the standard mainsail:

- Point your boat into wind with engine in gear.
- Make sure that the mainsheet is eased off and the reefs are free.
- Open the jammer.
- Hoist the sail being careful for the battens not to get jammed in the lazy-jacks.
- Make fast the halyard with the jammer.
- Trim the mainsail according to the wind and sea conditions.

To lower the standard mainsail:

- Haul up.
- Tighten the topping lift.
- Slacken off the halyard, lower the mainsail then furl it.
- Tighten the sheet.

- SHORTENING THE SAILS

Automatic reefing system:

- Move into the wind.
- Ease off the mainsheet a bit.
- Ease off the mainsail halyard.
- Take up the reef tack line.
- Tension the mainsail halyard.
- Set the mainsheet.

During automatic reefing, the mainsail halyard must not be dropped too far (risk of incorrect pulley positioning).

RUNNING RIGGING - MAINSAIL CIRCUIT - CRUISING SQUARE TOP MAINSAIL

RIGGING / SAILS

38

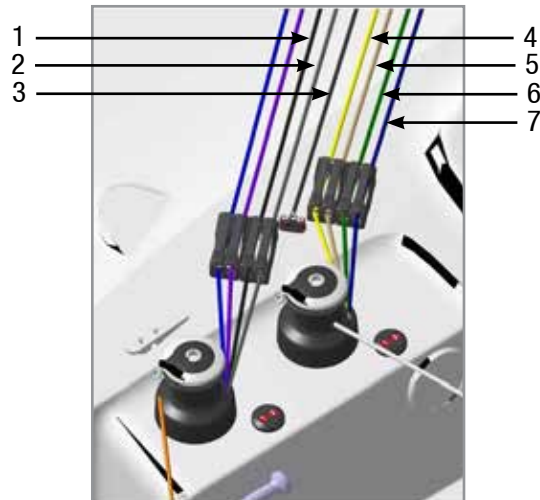

- 1 - Mainsail halyard.
- 2 - Boom topping lift.
- 3 - Lowering the mainsail.
- 4 - Reef 1.



- 5 - Mainsail sheet.
- 6 - Reef 2.
- 7 - Reef 3.
- 8 - Mainsail traveller adjustment.

FASTENING OF THE CRUISING SQUARE TOP MAINSAIL

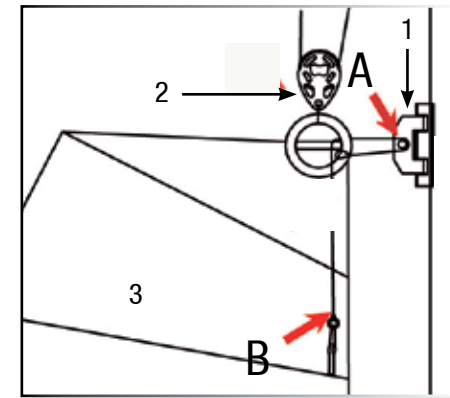

- 1 - Headboard traveller.
- 2 - Halyard block (to be fastened onto the headboard eye).
- 3 - Cruising square top mainsail.

- CRUISING SQUARE TOP MAINSAIL (optional extra)

The cruising square top mainsail halyard is lashed on the eyelet of the sail, not on the headboard traveller.

The square top will be properly set automatically once the sail is hoisted up.

FITTING OF THE MAINSAIL CRUISING SQUARE TOP SYSTEM

Refer to the drawing on the opposite page.

- Remove the pin of the headboard car (mark A).
- Make the 2 strand tackle as per the drawing on the opposite page.
- Put back the headboard car pin (mark A), adding the sheave.

The length of the headboard line is adjusted to the right dimension for a new sail at the sailmaker's.

The lashing (mark B) makes possible to make up for the possible lengthening of the rope due to ageing.

Nota: this system is patented by the INCIDENCES sailmaker.

- ROLLER FURLING JIB

Hoist the jib before you get under way, taking advantage of a windless period of time.

- Secure the head.
- Secure the halyard to the slide-swivel.
- Secure the tack to the drum and secure the sheets.
- Insert carefully the bolt rope into the hole, hoist the sail and take care you do not tear it.
- Haul the halyard taut enough but sway it up less than a sail on a standard stay.
- Hoist it until the horizontal creases disappear (the tension of the luff shall be adjusted after a few sea trips).
- Pull on the line from the cockpit to furl the jib.

RECOMMENDATION

Hand pre roll the drum to set the jib furling line on it. Pay attention to the drum furling direction: the sacrificial strip of the genoa shall be wrapped outside.

Never force when you furl or unfurl the head sails in case it seizes. Make sure a halyard is not caught in the roller furler.

RUNNING RIGGING - CODE 0

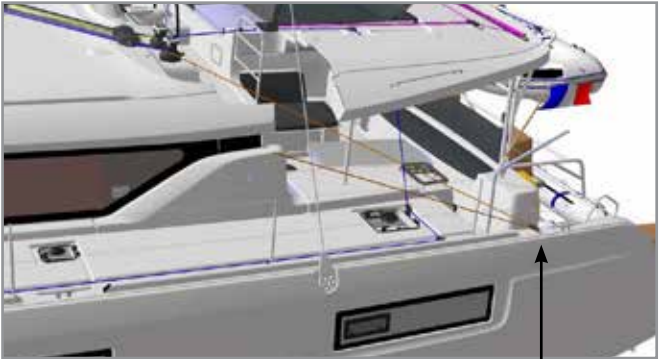

1

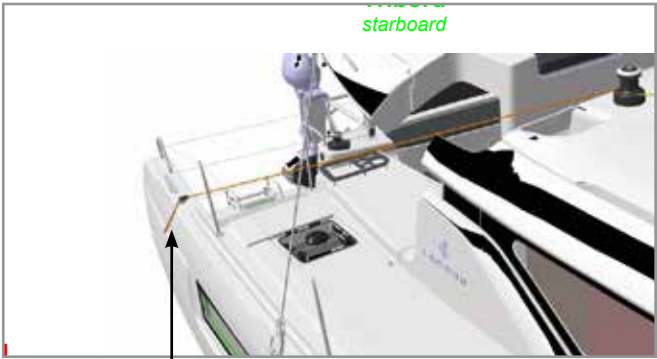

1

RIGGING / SAILS

40

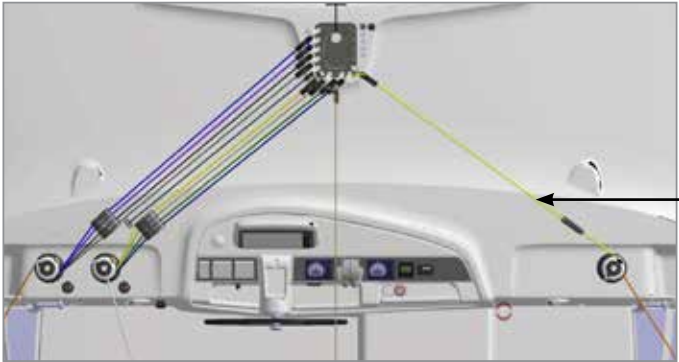

2

- 1 - Code 0 sheet.
- 2 - Code 0 halyard.

- CODE 0 (OPTIONAL)

Remove the forward lifelines when using the code 0 (risk of damage). Before getting under the way, take advantage of a windless period of time and hoist the code 0.

- Secure the swivel to the code 0 headboard.
- Secure the furling system to the tack clew.
- Put the furling system to the boomsprit with a snap shackle.
- Secure the halyard to the headboard swivel.
- Hoist the code 0.

Use the furling system line to furl or unfurl the code 0.

Code 0 sheets:

- Secure the sheets to the code 0 clew.
- Have the sheets go on the outside of the stay and shrouds and above the guardrails.
- Make fast the sheet leading blocks to the chainplates.
- Reroute the sheets to the genoa sheet winches.

WARNING

In some sailing trims, the code 0 may hide the fore navigation lights.

WARNING

Unrig the code 0 when not in use (risk of being UV damaged and inadvertently unfurled).

ACCOMMODATIONS

4

4.1 Saloon - Galley

4.2 Lighting

4.3 Portholes - Deck hatches

4.4 Curtains - Window blinds

4.5 Sliding window in the roof

SALOON - LIGHTINGS

ACCOMMODATIONS

44



REMOVABLE DRAWERS



ELECTRICAL PANEL



LIGHT SWITCHES



■ 4.1 Saloon - Galley

- FLOORBOARDS

The floorboards can be lifted up to have access to the different technical components on board.

RECOMMENDATION

To avoid premature ageing of the floorboards (dents, scratches) it is recommended to keep them as clean as possible and to remove shoes inside the boat.

- TABLE

You can switch the saloon and cockpit tables around.

An optional fitting allows to turn the saloon table into a double berth after having changed the legs and added extra cushions.

- DRAWERS

The drawers in the galley have an automatic closing function.

These drawers can be removed pushing on the levers on each side, under the rails.

When you reassemble it, clip the drawer before you push it back.

■ 4.2 Lighting

There are many ways of lighting the saloon, directly or indirectly, depending on the atmosphere you want to create.

After having turned on the 12 V circuit on board and the lighting circuit using the switch located on the electrical panel in the starboard hull companionway, you can turn the light on.

Based on the ref. marks on the photo page opposite:

- 1 - Saloon ceiling lights.
- 2 - Background lights for wall units.
- 3 - Ceiling lights in port and starboard companionways.
- 4 - Optional background lighting in the saloon.
- 5 - Optional background lighting for outside areas.
- 6 - Cockpit ceiling lights.

PORTHOLES - HATCHES - WINDOWS

OPENING PORTHOLE



BLIND AND MOSQUITO SCREEN ON DECK HATCH



SALOON CURTAIN



ACCOMMODATIONS

46

RAISING THE SLIDING ROOF WINDOW



■ 4.3 Portholes - Deck hatches

The portholes and deck hatches have locking systems to keep them in a closed position.

At anchor, intermediate opening position allows the ventilation of the boat.

The deck hatches are fitted with a blind and mosquito screen system that can be used even when the hatch is open.

Their handling shall be done carefully.

■ 4.4 Curtains - Window blinds

All the windows have blinds.

The opening hatches of the aft cabins are also fitted with curtains.

RECOMMENDATION

Pull and push the blinds carefully.

Take care to fasten them when they are fitted with the relevant systems.

■ 4.5 Sliding window in the roof (optional)

The saloon may be fitted with a large sliding roof window.

To release the window in the low position, pull the latches in the upper section of the window frame towards the centre.

WARNING

When at sea, the roof's sliding window MUST be closed.



UTILITY ABOARD

5

5.1 Refrigerators - Icebox - Icemaker

5.2 Microwave oven

5.3 Oven, hotplates

5.4 Television

5.5 Dishwasher

5.6 Air conditioning

5.7 Heating

REFRIGERATORS - ICEBOX - MICROWAVE OVEN

UTILITY ABOARD

50

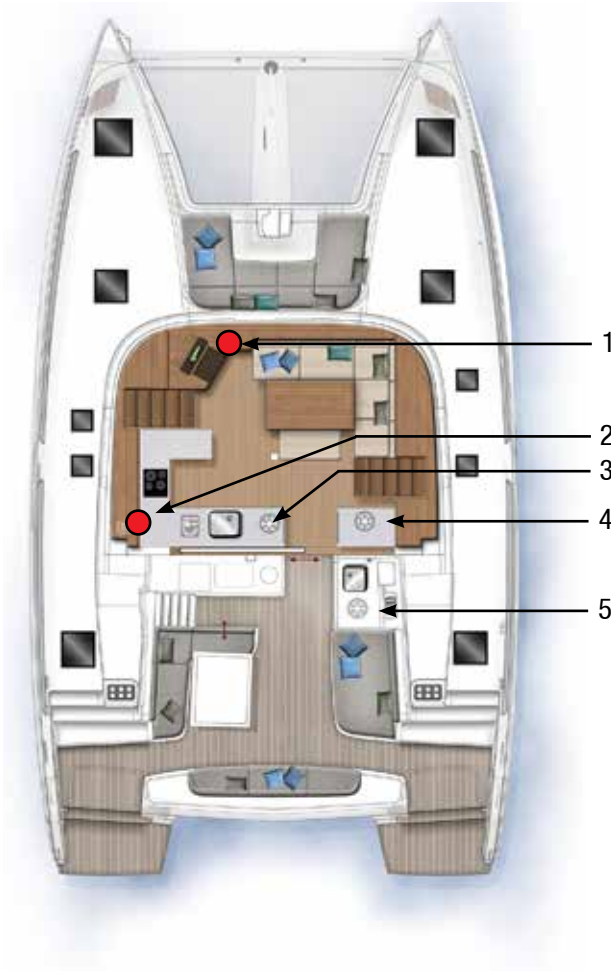

- 1 - Touch screen (according to the lay out).
- 2 - Microwave oven (optional).
- 3 - Refrigerator.
- 4 - Refrigerator / icebox (optional).
- 5 - Refrigerator / icemaker (optional).

Please note: you can find the same locations in the other accommodation version.

REFRIGERATOR



REFRIGERATOR + ICEBOX (OPTIONAL)



MICROWAVE OVEN (OPTIONAL)



■ 5.1 Refrigerators - Icebox - Icemaker

The boat standard features include a 130 l refrigerator located in the galley.

It may optionally be fitted with an icebox / refrigerator (144 l) located in the cupboard in the saloon starboard entrance.

The boat may be fitted with the following options:

- a freezer (110 l) and a fridge (155 l) in the galley.
- a fridge (80 l) in the cockpit.

Once the general 12 V on board circuit has been powered, turn on the elements using the refrigerated unit switch located on the electrical panel in the starboard hull companionway.

RECOMMENDATION

Defrost then drain the refrigerators and icebox before you stop the domestic 12 V circuit.

The boat may also be fitted with an optional icemaker (12 l and 8 kg of ice cubes / day) in the cockpit.

It is supplied with water coming from the fresh water system.

SUPPLY

Select the power source (generator or shore socket) via the touchscreen control panel or the inverter in the starboard companionway.

For the use and maintenance of the icemaker, please refer to its instruction guide.

Please note: the icemaker system is fitted with a carbon filter.

Regularly change the filter.

■ 5.2 Microwave oven (option)

The boat may optionally be fitted with a microwave oven located in the galley.

- Check the microwave plugging.
- Check that the sockets switch has been powered on the electrical panel.

SUPPLY

Select the power source (generator or shore socket) via the touchscreen control panel or the inverter in the starboard companionway.

RECOMMENDATION

The usage of the microwave oven through the inverter should remain limited.

Check the battery charge during the use of the inverter.

For the use and maintenance of the microwave oven, please refer to its instruction guide.

OVEN - HOTPLATES - TELEVISION - DISHWASHER

UTILITY ABOARD

52

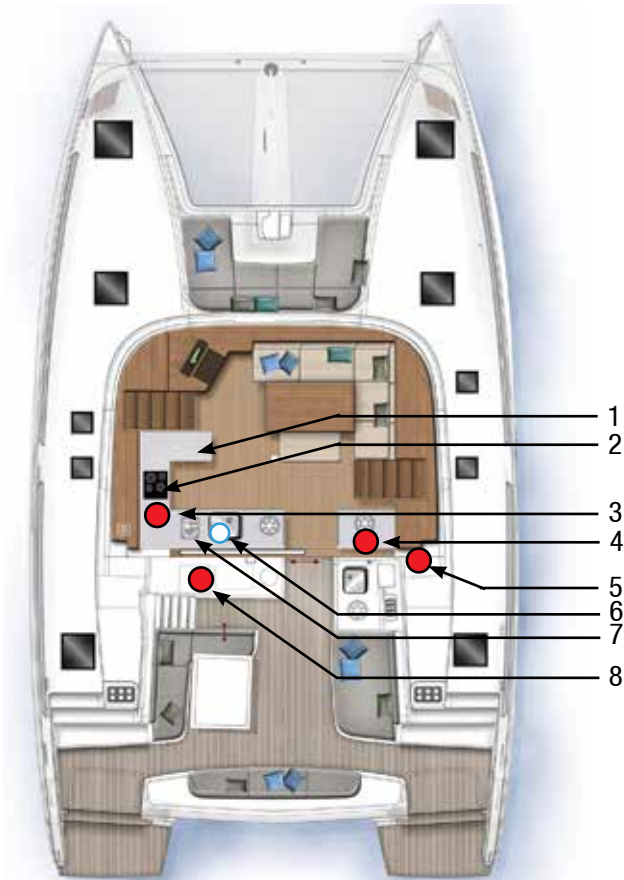

Please note: you can find the same locations in the other accommodation version.

GAS VALVES



SALOON TELEVISION



- 1 - Oven.
- 2 - Hotplates.
- 3 - Gas valves.
- 4 - Television.
- 5 - TV antenna booster.
- 6 - Dishwasher fresh water supply valve.
- 7 - Dishwasher.
- 8 - Gas bottles.

DISHWASHER FRESH WATER SUPPLY VALVE



■ 5.3 Oven, hotplates

The boat is standard fitted with gas oven and hotplates.

The gas valves are located in the cupboard under the hotplates.
The gas bottles are located in the cockpit port forward locker.

RECOMMENDATION

Shut the gas valves and the regulator tap when you do not use the hotplates.

■ 5.4 Television (option)

The saloon is optionally equipped with a TV and a CD / DVD player that can be turned on after switching on the on-board 12 V power supply when the boat is equipped with a 12 V to 110 V - 220 V / 2000 W inverter option.

If there is no converter, the TV is powered when 220 V is supplied from the shore or the generator.

An antenna amplifier is located behind a hatch to the right of the companionway in the starboard float.

Note: the owner's cabin may be fitted with a television that operates on the same principle as that in the saloon.

For the use and maintenance of the televisions, please refer to their instruction guide.

■ 5.5 Dishwasher (option)

The boat may optionally be fitted with a dishwasher located in the galley.

It is supplied with water coming from the fresh water system. Its water outlet is shared with the sink.

- Check that its fresh water supply valve in the locker under the sink is open.
- Check that its circuit breaker switch, located in the electrical room (aft starboard passageway locker), is set to ON.

SUPPLY

Select the power source (generator or shore socket) via the touchscreen control panel or the inverter in the starboard companionway.

RECOMMENDATION

**The usage of the dishwasher through the inverter should remain limited.
Check the battery charge during the use of the inverter.
Do not use the dishwasher when sailing.**

For the use and maintenance of the dishwasher, refer to its instruction guide.

AIR CONDITIONING

4 cabin version

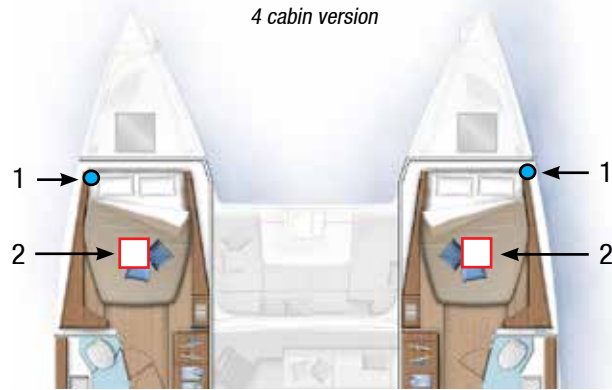

3 cabin version

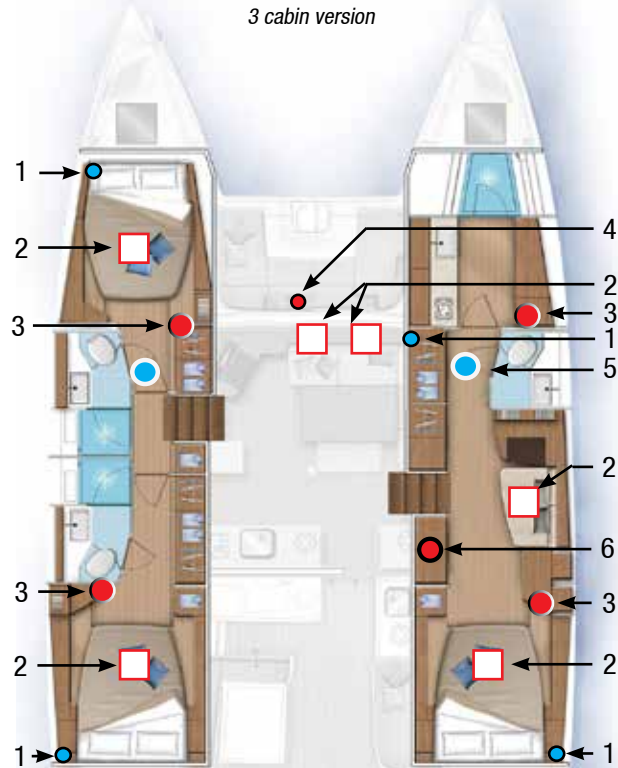

AIR CONDITIONING CONTROL



AIR CONDITIONING UNIT



SEA WATER PUMP + FILTER



- 1 - Drain valves + condensation.
- 2 - Air conditioning unit.
- 3 - Air conditioning control.
- 4 - Touch screen (saloon control).
- 5 - Sea water supply valve + sea water pump + filter.
- 6 - Disjoncteurs.

■ 5.6 Air conditioning (option)

The boat may be fitted with an optional reversible air conditioning system.

The air conditioning units are located in the cabins and in the saloon. You will find vents in every cabin, header and in the saloon.

Before you start the system:

- Open the circulating seawater systems (intake valves under the floorboards in the forward passageways).
- Open the seawater drain valves and the condensation valves on each air conditioning unit.

SUPPLY

- Select the power supply source (generator or shore power socket) from the touch control screen at the chart table.
- Check that the pumps and air conditioning units are switched on at the automatic breakers located in a cupboard to the right of the companionway in the starboard float.

Start the air conditioning unit in the desired area, select hot or cold and set the temperature using its control.

Regularly clean the filters on the conditioned-air systems and sea water suction valves.

For the drainage, use and maintenance of the air conditioning system, please refer to its instruction guide.

HEATING



- 1 - Heating / control / timer.
- 2 - Water system valve.
- 3 - Fuel tank.
- 4 - Boiler + water system valves.
- 5 - Boiler exhaust outlet.

*Please note: you can find the same locations
in the other accommodation version.*

UTILITY ABOARD

56

■ 5.7 Heating (option)

The boat may optionally be fitted with a diesel heating system with circulating water.

The boiler is located in the port engine compartment.

- Check that the water system valves are open (access through the port engine compartment) and behind each air heater.
- Turn on the boiler using the control / timer located in the saloon at the chart table.
- Set the temperature using the touchscreen controls for the cabins and the saloon.
- Set the fan speed using the touchscreen controls.

For the use and maintenance of the heating system, please refer to its instruction guide.

WARNING

Do not place fenders near emergency exits of the heat system boilers.

WATER SYSTEMS

6

- 6.1 Bilge pump system**
- 6.2 Grey waters**
- 6.3 Black waters**
- 6.4 Fresh water**
- 6.5 Watermaker**

BILGE PUMP SYSTEM - GREY WATERS

WATER SYSTEMS

60

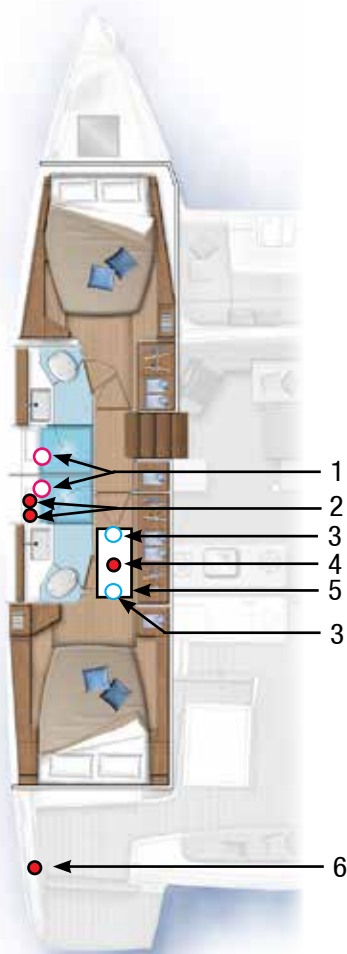

Note: each hull has the same components.
The same layout can be observed
in the other version.

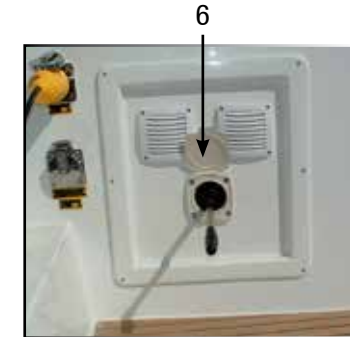

1 - Shower pump switch.

2 - Shower drain pump.

3 - Front / aft compartment outlet valve.

4 - Electric bilge pump.

5 - Hull sump.

6 - Manual bilge pump.

**SEA-COCK
OPEN**



**SEA-COCK
CLOSED**



Nota: each valve in the boat is identified.

■ 6.1 Bilge pump system

A main sump is under the floorboard of each hull. The fore and aft compartments are linked to these sumps by a bilge pipe and a valve (access under the floorboards).

Each well is emptied by two bilge pumps:

- A manual cockpit pump.
- An electric pump with manual and automatic release (electrical panel switch) located in the well.

RECOMMENDATION

Regularly check the valves and sea-cocks for proper operation and watertightness.
Regularly make sure the filters and strainers on the draining system are clean.

WARNING

The bilge pump system is not designed to provide buoyancy to the boat in case of damage.
The bilge pump system is designed to drive out the water being either sea spray or leaks but absolutely not the water coming through a hole in the hull, this hole being the result of a damage.

RECOMMENDATION

Always keep the bilge pumps switched on the automatic mode with alarm.
We advise you to test the bilge pumps every time you put out to sea.

■ 6.2 Grey waters

The grey waters (sink, washbasins) directly flow out via sea-cocks with valves.

Please note: a valve is closed when its handle is perpendicular to the hose and it is open when its handle is in line with the hose.

Grey waters are evacuated by the pumps behind the shower hatches. The pumps are switched on from the 12 V domestic circuit.

In order to empty the showers, use the pump switch located in the wet room.

RECOMMENDATION

When mooring in a harbour, if possible, use the sanitary facilities provided by the port authority.
In some harbours or countries, wastewater disposal is forbidden. You will then have to use the waste tank.

BLACK WATERS

WATER SYSTEMS

62

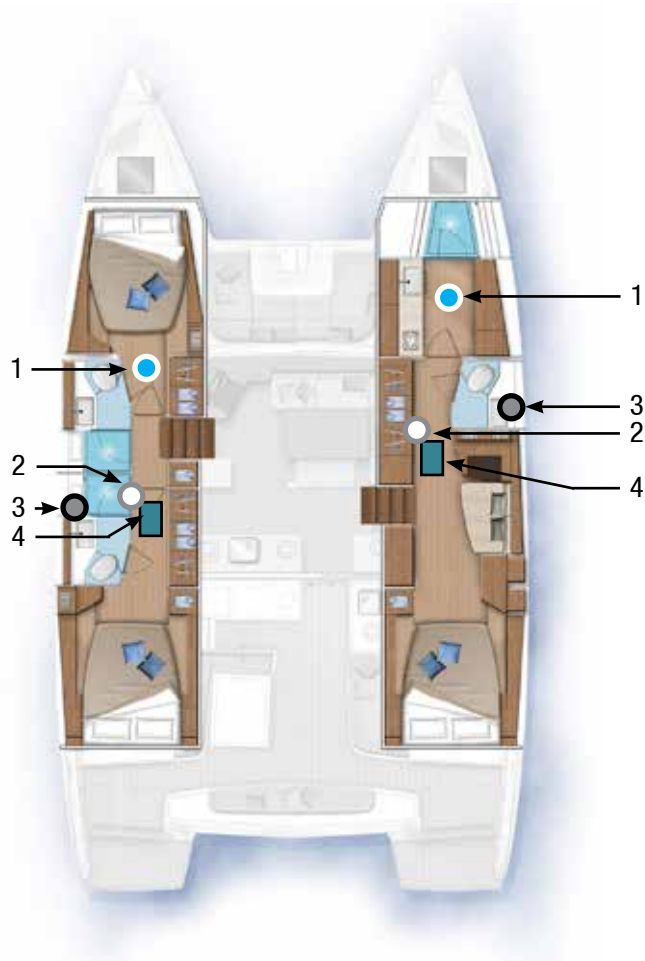

Please note: you can find the same locations in the other accommodation version.



- 1 - WC water inlet valve.
- 2 - Drain valve on hull.
- 3 - Drain bung hole on deck.

- 4 - Holding tank.
- 5 - Holding tank gauge.
- 6 - Switch of the electric toilets.



■ 6.3 Black waters

The boat is fitted with manual toilets and a 120 L black water tank in each floater as standard.

She may be fitted with optional electric toilets.

• USE OF THE MANUAL TOILETS

- Open the water inlet and drain valves.

To empty the bowl:

- Set the control lever of the pump slantwise (FLUSH) and operate the pump.

To dry the bowl:

- Set the lever back vertical (DRY) and operate the pump.

In order to avoid clogging the toilets, use absorbent paper only and pump until the emptying hose is completely empty.

Regularly rinse the toilets with fresh water.

Close the valves after each use.

• USE OF THE ELECTRIC TOILETS

The electric toilets are rinsed with sea water.

Electrical pumps, filters, and supply valves are located in different wet rooms and under the floors of the passageways.

- Switch on the 12 V domestic circuit.
- Open the water inlet and drain valves.

One of the switches next to the toilets makes possible a water intake cycle and a water outlet cycle.

The second switch makes possible to carry out a rinse cycle.

Rinse the toilets with fresh water and regularly clean the filters.

Close the valves after each use.

For the use and maintenance of the electric toilets, please refer to their instruction guide.

• USE OF THE HOLDING TANKS

The tanks are accessed via the passageway floorboards.

Make sure the drain valve of the tank is closed in order to avoid any inadvertent discharge (the valve is closed when the handle is perpendicular to the hose).

Tank drainage:

- In an authorized area, open the drain valve.
- In a marina equipped with an organic waste suction system, fit the suction hose into the tank through the deck filler.
- Start the pump of the suction system.

Regularly rinse the holding tank.

The tanks shall be emptied when the boat is berthed in negative temperatures.

WARNING

Use the suction systems in marinas to empty your holding tank.

In order to respect environment, do not discharge your holding tanks near the shore.

FRESH WATER

WATER SYSTEMS

64

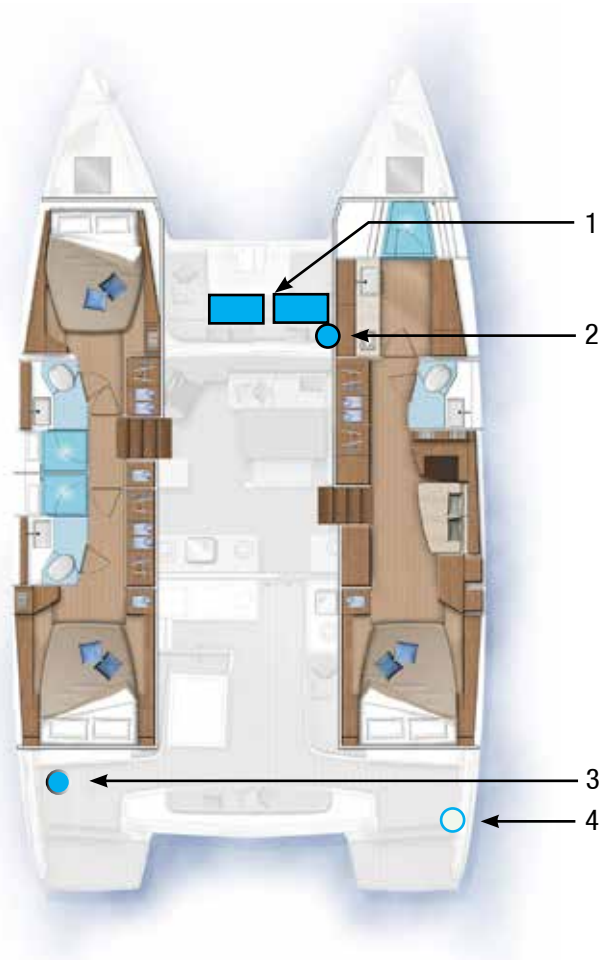

Please note: you can find the same locations in the other accommodation version.

FRESH WATER TANKS



WATER GROUP



- 1 - Fresh water tanks.
- 2 - Deck filler.
- 3 - Pressure water pump.
- 4 - Shore fresh water supply (optional).

SHORE FRESH WATER SUPPLY



■ 6.4 Fresh water

- FRESH WATER TANKS

The boat is standardly equipped with two 300-litres tank located in the fore peak starboard locker.

To prevent any handling mistake, never fill the water and fuel tanks at the same time.

A front filler is provided to fill the tank.

During filling, avoid handling contaminants near the fillers.

Open and close the filler caps with the right key.

Check the filler cap seal for condition during filling.

Never insert the water filling hose deep down into the system in order to prevent any over-pressure in the systems.

RECOMMENDATION

Pay attention to the quality of the water for the filling up.

Check if it is drinking water.

If the boat is not used for long, purify the tanks and pipes with proper treatment.

Please note: the capacity of the fresh water tank(s) indicated on the page 'SPECIFICATIONS' may be not completely usable depending on the trim and load of the boat.

- PRESSURE WATER PUMP

The pressure water pump is situated the port engine compartment. Its starting is done by using a switch on the electrical panel.

RECOMMENDATION

Never operate the water system equipment when the valves are closed or when the tanks are empty (the electrical equipment may be damaged).
Check the different water filters for condition.

- WATER GAUGE

Check the water level in the tank(s) via the gauge displayed on the touch screen in front of the chart table in the saloon.

- SHORE FRESH WATER SUPPLY (OPTIONAL)

The shore fresh water supply is located in the starboard aft transom extension.

To use the marina fresh water:

- Connect the shore supply.
- Set the pressure water pump switch to 'OFF'.

RECOMMENDATION

When you leave the boat unattended, systematically disconnect the shore fresh water supply.

SEA WATER PUMP - WATER HEATER

WATER SYSTEMS

66

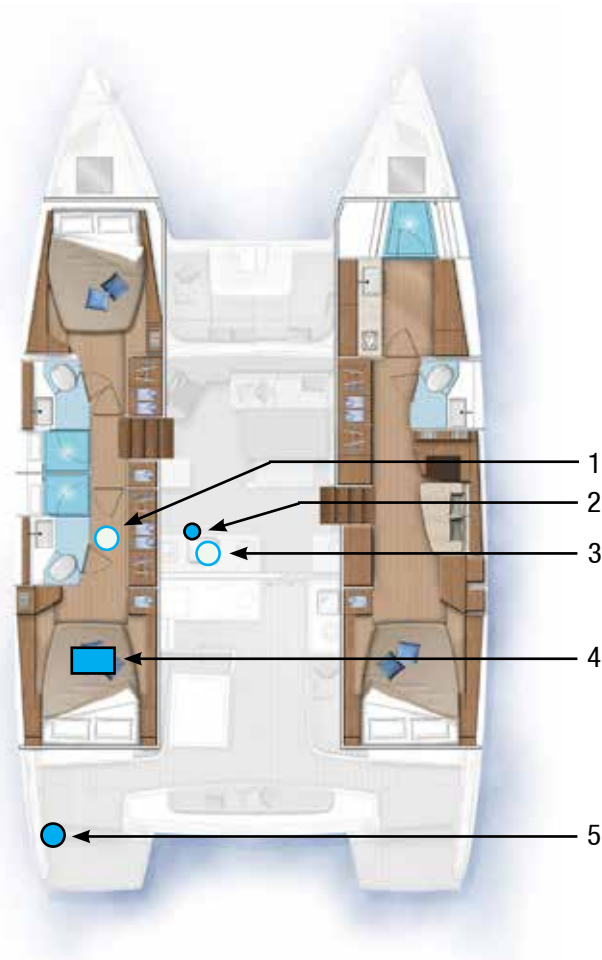

Please note: you can find the same locations in the other accommodation version.

SEAWATER PUMP SWITCH



WATER HEATER



AFT TRANSOM SHOWER



- 1 - Sea water supply valve.
- 2 - Electric pump switch.
- 3 - Electric sea water pump.
- 4 - Water heater.
- 5 - Shower.

- EXTERIOR SHOWER

A shower supplied with hot and cold water (mixing faucet) is located on the port side of the transom.

It is supplied by the pressure water pump.

WARNING

In period of frost, do not forget to empty the cockpit shower, even if there is someone onboard the boat.

- WATER HEATER

The water heater is located under the berth of the aft starboard cabin. It has a capacity of 60 litres.

The water heater functions automatically when the engine is on or when set on the 110 V - 220 V circuit (generator or shore supply socket) after having activated its circuit breaker on the electrical panel in the saloon.

The hot water temperature is pre-set using the thermostatic tap located on the water heater.

RECOMMENDATION

When the water heater is not used, switch it off using its 110 V - 220 V circuit.

Before you switch it on using the 110 V - 220 V circuit, check the water heater is full of water.

- SEA WATER PUMP

Depending on the lay-out, the boat can be equipped with an electric pump that can supply a tap of the sink with seawater.

After switching on the on-board 12 V voltage supply circuit, press the switch on the front of the galley cabinet.

WATERMAKER

WATER SYSTEMS

68

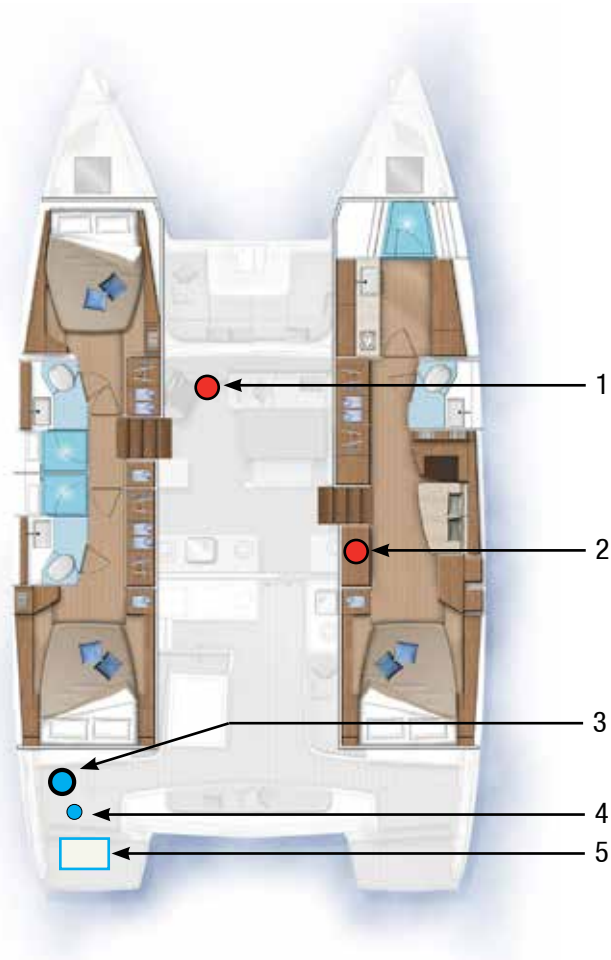

Please note: you can find the same locations in the other accommodation version.

WATERMAKER



WATERMAKER FILTER + WATER SUPPLY VALVE

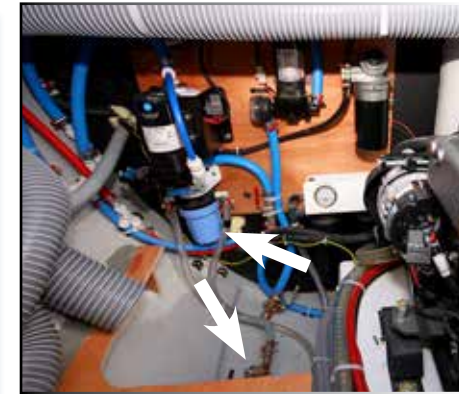

- 1 - Control.
- 2 - Automatic breaker.
- 3 - Filter.
- 4 - Sea water supply valve.
- 5 - Watermaker.

WATERMAKER CONTROL



■ 6.5 Watermaker (option)

The boat may optionally be fitted with a water maker (63 l / hour) located in the port engine compartment.

OPERATION

The watermaker works in 12 V.

Check that the relevant circuit breaker located in a cupboard to the right of the companionway in the starboard float.

Check that the seawater supply valve and the drain valve are open (accessed in the port engine compartment).

SUPPLY

Start the water maker using its control located on its panel or using its remote control (under the chart table).

Check the level of fresh water in the tank when the watermaker is working.

Regularly clean the different system filters.

For the use and maintenance of the watermaker, please refer to its instruction guide.

RECOMMENDATION

The watermaker shall be used exclusively in clear waters.

ELECTRICITY

7

- 7.1 12 V circuit**
- 7.2 Inverter**
- 7.3 Solar panels**
- 7.4 110 V - 220 V circuit**
- 7.5 Electronics**

12 V ELECTRICAL EQUIPMENT



1



2



3



4



5

ELECTRICITY

72

- 1 - Switch of the inverter.
- 2 - Automatic breaker of the inverter.
- 3 - 12 V / 110 V - 220 V inverter.
- 4 - 12 V service batteries.
- 5 - Battery chargers.

- 6 - Electrical panel.
- 7 - Cut out coupling / batteries + port engine.
- 8 - Boat and starboard engine cutouts.
- 9 - Solar panels.
- 10 - Automatic breaker of the solar panels.

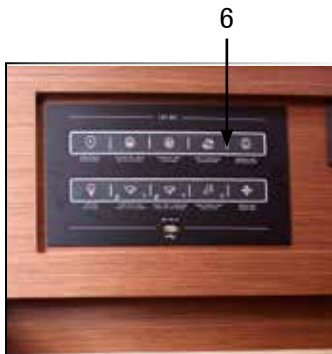

6



7



8

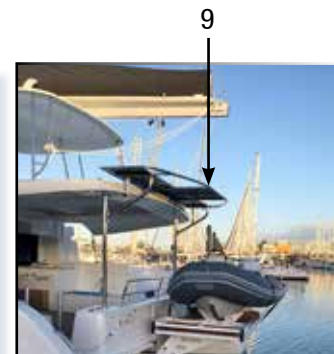

9

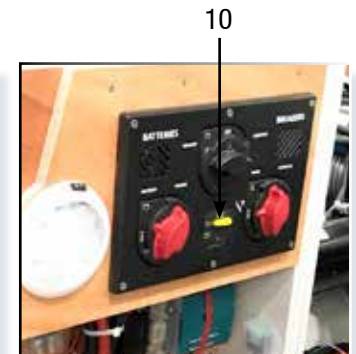

10

■ 7.1 12 V circuit

The main domestic circuit is supplied in 12 V.

The service batteries are located in the starboard engine compartment.

The generator battery (optional extra) is located in the central locker of the forward swim deck.

The starboard engine battery and the port engine battery are located in their respective engine compartments.

The starboard engine and on-board cut-outs are located in the starboard engine compartment.

The port engine cut-out is located in the port engine compartment.

For safety reasons, a coupling system for the engine batteries (cut-out located in port engine compartment) allows the engine to start if the relevant battery is faulty.

The generator includes its own cut outs located in the central locker of the forward swim deck.

BATTERY CHARGERS

The batteries can be charged either by the engine alternator or by the 110 V - 220 V / 12 V - 60 A battery charger.

According to the lay out, the boat may optionally be fitted with an extra 110 V - 220 V / 12 V - 40 A charger.

The battery chargers are located in the starboard engine compartment.

SUPPLY OF THE CHARGERS

Select the power supply source (generator or shore power socket) from the touch control screen at the chart table.

The 12 V consuming appliances circuit breakers are located in a locker to the left of the companionway in the starboard float.

They can be wound by pressing a black lug.

■ 7.2 Inverter

The boat is optionally equipped with a 12 V / 110 V - 220 V / 2000 Va inverter located in a cupboard to the right of the companionway in the starboard float.

The inverter supplies the sockets with 110 V - 220 V.

The inverter power switch is located in the companionway in the starboard float.

Check that the switch on the inverter is in REMOTE position in order for the main switch to be turned on.

RECOMMENDATION

Check the battery charge during the use of the inverter.

■ 7.3 Solar panels (option)

The boat may be optionally equipped with solar panels (4 x 120 W).

In case of solar panel malfunctioning, check the automatic breaker located in the starboard engine compartment.

SHORE POWER SOCKETS - GENERATOR

**SHORE POWER SOCKETS
CIRCUIT BREAKERS**



GENERATOR



GENERATOR CUT-OUT



ELECTRICITY

74

GENERATOR BATTERY



**CHARGER + AUTOMATIC
BREAKERS OF THE GENERATOR**



**VALVE + WATER FILTER
OF THE GENERATOR**



■ 7.4 110 V - 220 V circuit

• SHORE POWER SOCKETS

Both shore supply sockets are located in the starboard transom. They supply the 220 V circuit and the battery chargers, as well as the air conditioning.

One socket only supplies power to the 110 V circuit, the battery chargers and air conditioning.

Before you plug in or unplug the boat / shore power supply cable, switch off the shut off device connected to the shore supply.

Connect the boat / shore power supply cable in the boat before connecting it to the shore supply socket.

Unplug the boat / shore supply cable on shore first.

Close the protecting cover of the shore supply socket when you do not use the plug.

The shore power plants are protected by circuit breakers located in the starboard engine compartment (+ two automatic breakers located in the starboard companionway).

WARNING

Before using the shore power socket, imperatively check the shore power is 32 Ah.

DANGER

Never let the end of the boat / shore supply cable hang in the water; the result may be an electric field liable to hurt or kill the swimmers nearby.

• GENERATOR

The generator (optional extra) is located in the port locker of the forward swim deck.

Its function is to re-supply the batteries via the chargers and supply 110 V - 220 V electricity on board.

OPERATION

After turning ON the cut outs located in the central locker of the forward swim deck, the generator can be switched on either at the generator itself or via the touchscreen on the chart table.

- Make sure that the seawater cooling valve (access under the floor of the port passageway) and separator drain valve (access via the technical room in the port bow).
- Select the fuel tank using the pull handle located to starboard of the aft port cabin berth.

For the use and maintenance of the generator, please refer to its instruction guide.

TOUCH SCREEN - AUTOMATIC BREAKERS

TOUCH SCREEN

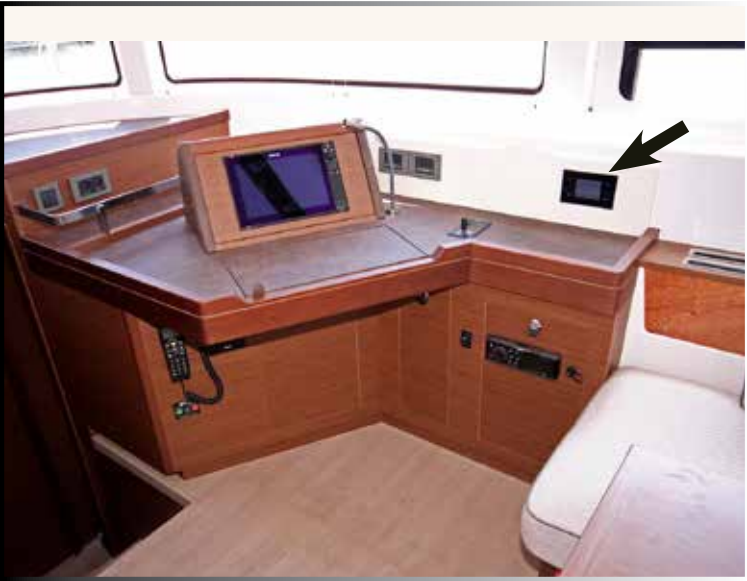

CONSUMING APPLIANCES
CIRCUIT BREAKERS



ELECTRICITY

76

- CHECKING OF THE 110 V - 230 V CONSUMING APPLIANCES

The touchscreen control panel next to the chart table lets you select the power supply (shore power socket or generator) for the various 110 V - 220 V domestic appliances.

The converter operates independently after switching on the 12 V on-board circuit (power switch located in the companionway in the starboard float).

RECOMMENDATION

Check the battery charge during the use of the inverter.

- USE OF THE 110 V - 220 V POWERED APPLIANCES

SWITCHING ON THE APPLIANCES

In order to be able to use the 110 V - 220 V powered appliances (microwave oven, etc), it is advisable:

- Make sure that the circuit breakers are switched OFF on the 110 V - 220 V circuit breaker panel.
- Switch on the 110 V - 220 V source (start the generator or connect a shore power socket to shore).
- Select this source on the touch screen so that this source supplies the boat (110 V - 220 V electrical selection panel) or turn on the inverter for the outlets.

- Turn on the circuit breakers for the units to be used by using the 110 V - 220 V circuit breaker panel.
Then start the appliance with its own controls.

To start 110 V - 220 V elements, wait for 10 to 15 seconds between the start up of each new component (in order to allow the generator to become stabilized and be able to give the power necessary for the starting up).

STOPPING THE 110 V - 220 V POWERED APPLIANCES

To stop the 110 V - 220 V powered appliances (microwave oven, etc.) it is advisable to do as follows:

- Stop the appliance with its own controls.
- To stop 110 V - 220 V elements, wait for 10 to 15 seconds between the stop of each new component (in order to allow the generator to become stabilized).
- Turn off the unit circuit breakers by using circuit breaker panel.
 - Turn to OFF the 110 V - 220 V source selector (generator or shore power) or turn off the inverter.

WARNING

Before you turn the 110 V - 220 V source selector to OFF, make sure no other appliance is working (danger of an electric arc that would destroy the changeover switch and risk of damaging the generator).

EMERGENCY SELECTOR SWITCHES - ELECTRONICS

MANUAL SELECTOR SWITCHES



AUTOMATIC PILOT RAM



**LOG DEPTH SOUNDER SENSOR +
AUTOMATIC PILOT COMPASS**

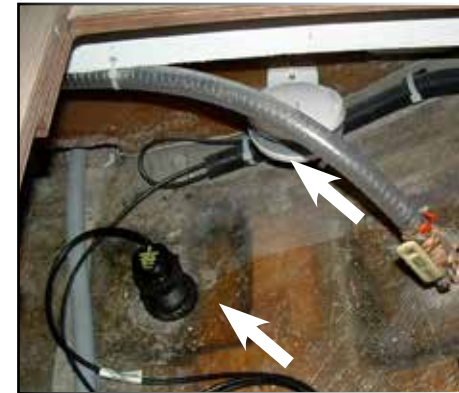

ELECTRICITY

78

- **MANUAL 230 V SUPPLY SELECTOR SWITCHES**

In case of malfunctioning of the multifunction touch screen, it is possible to use the manual emergency switches to supply 220 V to the boat.

The manual selector switches are located in a locker to the left of the companionway in the starboard float.

WARNING

Ensure that all appliances are switched off before using the switches.

Use the handle to select Generator or Shore power socket.
Position the handle to OFF after use.

Note: while the system is in manual mode, the multifunction touch screen is locked (padlock icon shown on screen) and cannot be used to select the power supply source, even when the handle is OFF.

■ 7.5 Electronics

The boat may be fitted with an optional electronic pack and different navigation aid accessories.

For the use and maintenance of all these components, please refer to their instruction guides.

The ram, the auto pilot and the calculator are located in the starboard engine compartment.

The compass and the sounder and depth finder are located under the floor in front of the entrance of the front port cabin.



ELECTRIC LAYOUT

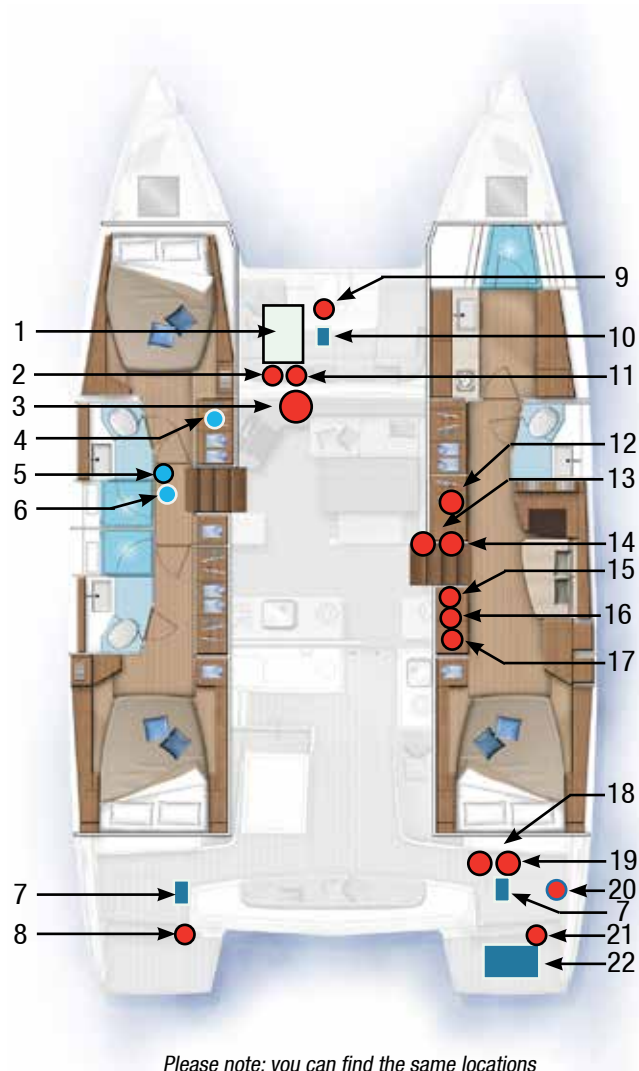

Please note: you can find the same locations in the other accommodation version.

- 1 - Generator.
- 2 - Generator automatic breaker.
- 3 - Touch screen.
- 4 - Drain valve of generator.
- 5 - Generator water filter.
- 6 - Generator water inlet valve.
- 7 - Engine battery.
- 8 - Port engine cut-out + coupling / engine batteries cut outs.
- 9 - Generator cut outs.
- 10 - Generator battery.
- 11 - Generator battery charger.
- 12 - Manual emergency switches.
- 13 - Electrical panel.
- 14 - Inverter switch.
- 15 - 12 V / 110 V - 220 V inverter.
- 16 - Inverter automatic breaker.
- 17A - Circuit breakers - air conditioning + domestic 110 V - 220 V.
- 17A - Circuit breakers - equipment 12 V.
- 18 - Battery chargers.
- 19A - Automatic breaker of the shore power socket - Board.
- 19B - Automatic breaker of the shore power socket - Air conditioning.
- 20A - 110 V - 220 V shore power socket / Board.
- 20B - 220 V shore power socket / Air conditioning.
- 21 - On board and starboard engine cut-outs.
- 22 - 12 V domestic batteries.

SUMMARY FOR THE 12 V COMPONENTS

CHARGE AND ELECTRICAL CONVERSION

1 x 220 V / 12 V - 60 A charger	Engines + board
1 x 220 V / 12 V - 40 A charger (optional extra)	Engines + board
2 x 12 V - 125 A alternators	Recharge service bank, battery engines, generator

BATTERIES / CONSUMING APPLIANCES

12 V CURRENT	VOLTAGE	START (+ PROTECTION)	PROTECTION
Service batteries	12 V - 140 Ah (standard)		
Navigation electronics	12 V	12 V electrical panel	Chart table terminal block
Lighting	12 V	12 V electrical panel	
Navigation lights	12 V	12 V electrical panel	
Refrigerators, icebox (optional)	12 V	12 V electrical panel	
Electric toilets (optional)	12 V	12 V electrical panel	12 V terminal bloc
Deckwash pump (optional)	12 V	12 V electrical panel	12 V terminal bloc
Bilge pumps	12 V	12 V electrical panel	
Winches (optional)	12 V	12 V board	Starboard passageway
Windlass	12 V	12 V board	Starboard passageway
Watermaker (optional)	12 V	12 V board	Starboard passageway
VHF	12 V	12 V board	12 V terminal bloc
Hifi	12 V	12 V board	12 V terminal bloc
Autoradio	12 V	12 V board	12 V terminal bloc
12 V sockets	12 V	12 V board	12 V terminal bloc
Engine batteries (x2)	12 V - 110 Ah		
Generator battery	12 V - 50 Ah		
Domestic batteries (x3 as standard + 3 fitted out)	12 V - 140 Ah		

7

ELECTRICITY

81

SUMMARY FOR THE 110 V - 220 V COMPONENTS

GENERATOR

Force 11 Kva in 220 V 100% of its charge in 220 V - 50 Hz
Force 13,5 Kva in 110 V 100% of its charge in 110 V - 60 Hz

SHORE POWER SOCKETS

Shore power socket Board 220 V - 50 Hz	32 A simple shore power socket	Starboard transom connection
Shore power socket Air conditioning 220 V - 50 Hz	32 A simple shore power socket	Starboard transom connection
Shore power socket Board 110 V - 60 Hz (US version)	32 A simple shore power socket	Starboard transom connection
Shore power socket Air conditioning 110 V - 60 Hz (US version)	50 A simple shore power socket	Starboard transom connection

ELECTRICITY

82

ELECTRIC DISTRIBUTION

Touchscreen selection	Air conditioning supplied by generator or shore power
Touchscreen selection	Board supplied by generator or shore power (or 12 V / 220 V - 2000 Va inverter)

CHARGE

1 x 220 V / 12 V - 60 A charger	Recharging the service bank by generator or shore power
1 x 220 V / 12 V - 40 A charger optional extra	Recharging the engine batteries by the generator or the shore
1 x 220 V / 12 V - 25 A charger optional extra	Recharging the generator battery from the shore

SUMMARY FOR THE 110 V - 220 V COMPONENTS

CONSUMING APPLIANCES	VOLTAGE	ELECTRICAL PANEL
Television (optional)	220 V	Inverter or 220 V panel
Outlets	220 V	Inverter or 220 V panel
Dishwasher (optional)	220 V	Inverter or 220 V panel
Microwave oven (optional)	220 V	Inverter or 220 V panel
Icemaker (optional)	220 V	Inverter or 220 V panel
Water heater	220 V	220 V panel
Air conditioning (optional)	220 V	220 V panel



MOTORIZATION

8

8.1 Engines

8.2 Fuel

8.3 Propellers - Anodes

8.4 Dash board

ENGINE LAYOUT

**PORT ENGINE +
COUPLING CUT-OUTS**



**STARBOARD ENGINE
CUT OUT**



POWER SUPPLY SWITCH



**ENGINE WATER
INLET VALVE**



MOTORIZATION

86

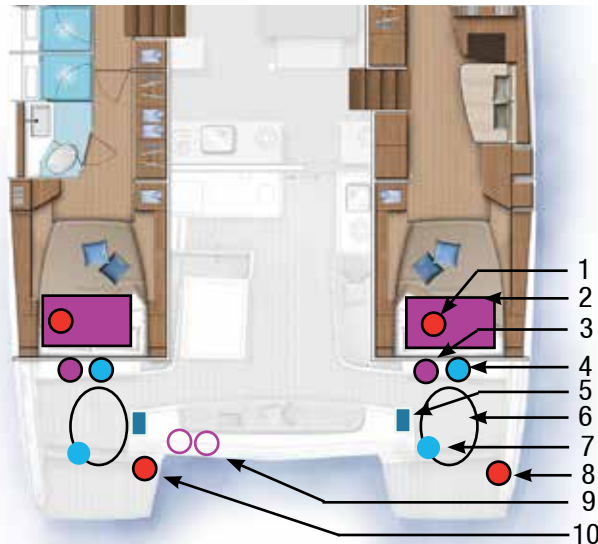

*Please note: you can find the same locations
in the other accommodation version.*

WATER FILTER



- 1 - Fuel valve.
- 2 - Fuel tank.
- 3 - Fuel filter.
- 4 - Sea water filter.
- 5 - 12 V battery.
- 6 - Engine.
- 7 - Engine water inlet valve.
- 8 - Starboard engine cut-out.
- 9 - Fuel tank filler.
- 10 - Port engine + coupling cut-outs.

Each hull has the same components.
Nota: each valve in the boat is identified.

■ 8.1 Engines

• ACCESS

You have access to the engines through the transom extension hatches.

WARNING

**Stop the engines before opening the hatches.
In case you have to intervene when the engines are running:**

- Stay away from belts and mobile parts.
- Be careful with full clothes, long hair, rings, etc. (they may be caught).
- Wear appropriate clothes (gloves, caps, etc.).

• STARTING

Before starting the engines:

- Check the fuel valves are open (access under the aft cabins berths, on the port and starboard tanks).
- Open the valves of the engine cooling system.
- Switch on the electrical circuit, setting the engines cutouts to 'ON' (accessed in the port and starboard engine compartments).
- Check that the power supply switches on the engines (red knobs) are in the RUN position.

After having checked that the reverser handles are set on neutral, start the engines.

Please carefully read the engine instruction guide supplied with the boat; it gives you detailed explanations as to the best use of the engines and relative operations.

• ENGINE START WITH BATTERY COUPLING

In case one of the start batteries is not available:

- Activate (ON position) the coupling cut out located in the port engine compartment.
- Start the engine concerned.
- Turn the coupling cutout back to the OFF position.

Nota: in the standard configuration, the engine batteries are recharged by their respective engines.

• ENGINE MAINTENANCE

Please follow the instructions for maintenance appearing in the guide supplied with the engines.

• ENGINE WATER INLETS

The water inlet valves of the engines (access through the engines compartments) shall absolutely be open before you start the engines.

Keep the strainers of the engine water inlet valves in the best possible state of cleanliness.

Brush the strainers when the boat is careened.

Be careful: do not cover the strainers with antifouling paint.

Get used to checking immediately after starting the engines if water is expelled with the exhaust gases.

If water does not flow out:

- Stop the engines immediately.
- Check the valves are open.

Close the water inlet valves if the boat is left unattended for long.



FUEL

FUEL TANK DECK FILLERS



FUEL GAUGE TOUCH SCREEN



FUEL VALVE



FUEL FILTER



Inspect and clean the water strainers regularly (access through the engine holds).

- VENTILATION OF THE ENGINE BAY

The engine bay fans start up automatically as soon as the engines start.

■ 8.2 Fuel

- FUEL TANKS

The boat is fitted with two tanks.

Each of them is filled separately.

Check the fuel gauge on each tank from the touch screen in front of the chart table.

- FILLING

To prevent any handling mistake, never fill the water and fuel tanks at the same time.

During filling, avoid handling contaminants near the fillers.

Open and close the filler caps with the right key.

Use both fillers to fill the tanks with fuel.

DANGER

Stop the engines and put out your cigarettes when you are filling the fuel tanks.

- MAINTENANCE OF THE TANKS

Regularly check the O rings of the fillers for good condition (to prevent water from entering the tanks).

Do not turn off the fuel taps after each use (except in case the boat is unattended for long).

Keep the fuel tanks as full as possible (to avoid condensation).

Every year check the fuel system for condition (hose, valves, etc.).

Ask a professional to carry out the works on the damaged parts of the fuel system.

Please note: the capacity of the tanks (that is indicated in the page 'SPECIFICATIONS') may be not completely useable according to the trim and load of the boat.

Always keep 20% fuel as a reserve.

- FUEL FILTERS

In order to prevent any water infiltration, the fuel runs through two filters: the first one is on the pipe that links the tank to the engine (designed as a water decanter and pre-filter), the second one is an integral part of the engine (designed to filter fuel finely). To know when you have to intervene and how frequently you have to change them, please refer to the engine instruction guide.

Drain it by undoing the knurled screw on the base of the decantation bowl (but do not remove it).

Allow to flow into a box till the fuel looks clean.

Do it several times a year.

Change the pre-filter at least once a year (access to it when you remove the bowl).



DASH BOARDS - FOLDING PROPELLER - ANODE

DASH BOARDS



MOTORIZATION

90

**FOLDING PROPELLER
+ ANODE**



■ 8.3 Propellers - Anodes

- PROPELLERS

The propellers supplied with your boat are the result of tests carried out jointly with the engine manufacturer.

Do not change them without consulting a specialist.

- FOLDING PROPELLERS (OPTIONAL EXTRA)

Remove the folding propellers at the end of each season, dismantle them and clean them carefully.

Grease the thrust bearing surfaces and teeth.

Check that the blades move easily.

- ANODES

Regularly check the sacrificial anodes corrosion.

The wear of the anodes depends on numerous factors and their lives may highly vary. Change them whenever necessary.

Never paint an anode.

Ask a professional to check and maintain the whole propulsion system.

■ 8.4 Dash board

On the dash board you can find all the functions to monitor the engine.

Please refer to the engine instruction guide supplied with the boat; it gives you explanations about the indicator lights, dials and warning lights on the dash board.



WINTER STORAGE

9

- 9.1 Laying up**
- 9.2 Protection**

WINTER STORAGE

94

■ 9.1 Laying up

- Take ashore all the ship's log, the ropes that are not used for mooring her, the galley equipment, supplies, clothes, the safety equipment.
- Check the expiry dates of the safety equipment.
- Have the liferaft overhauled.

Take advantage of this laying up to draw up a complete inventory of the equipment.

■ 9.2 Protection

• WATER SYSTEM

- Drain the fresh water system.

Let water run from the taps until the system runs dry.

Check that there is no water left in the pipes and hoses (possible low points).

- Take off the filters, remove the water.

Clean the filters if necessary then put them back.

- Drain the water heater.

Check that there is no water left.

Close the drain.

- Lubricate all the water inlet valves and sea cock fittings.
- Rinse and completely drain the toilets bowls.

• INSIDE

- Seal air inlets as much as you can.

- Install an air dehumidifier in the saloon and leave the cabin and storage unit doors open (stowage cupboards, icebox).
- Leave the ventilators of the deck hatches in open position to avoid condensation, mold and oxidation.
- Leave the cushions outside for long before putting them back into the boat in the upright and side position in order to have minimum contact surfaces.
- Drain and clean the bilges.
- Possibly place the floorboards in a vertical position to make possible the ventilation of the different compartments.
- Open the refrigerators / icebox doors.

• OUTSIDE

- Carefully drain the cockpit shower.
- Thoroughly rinse the hull and deck.
- Lubricate all the mechanical and mobile parts with vaseline (bolts, hinges, locks, etc.).
- Protect all ropes and mooring lines against chafing.
- Protect the boat to the highest degree with fenders.
- Make sure the boat is properly moored.

• ENGINES

The engines winterizing has to be prepared by a specialist.

The preparation for winterizing is different according to the place where the boat will be stored - either in the water or on the shore.

RECOMMENDATION

All these recommendations do not make up an exhaustive list. Your dealer will give you the advice you need and will carry out the technical maintenance of your boat.

HANDLING

10

10.1 Preparation

10.2 Crane lifting

10.3 Mast stepping - Mast unstepping

DIMENSIONS FOR CRANE LIFTING

HANDLING

98

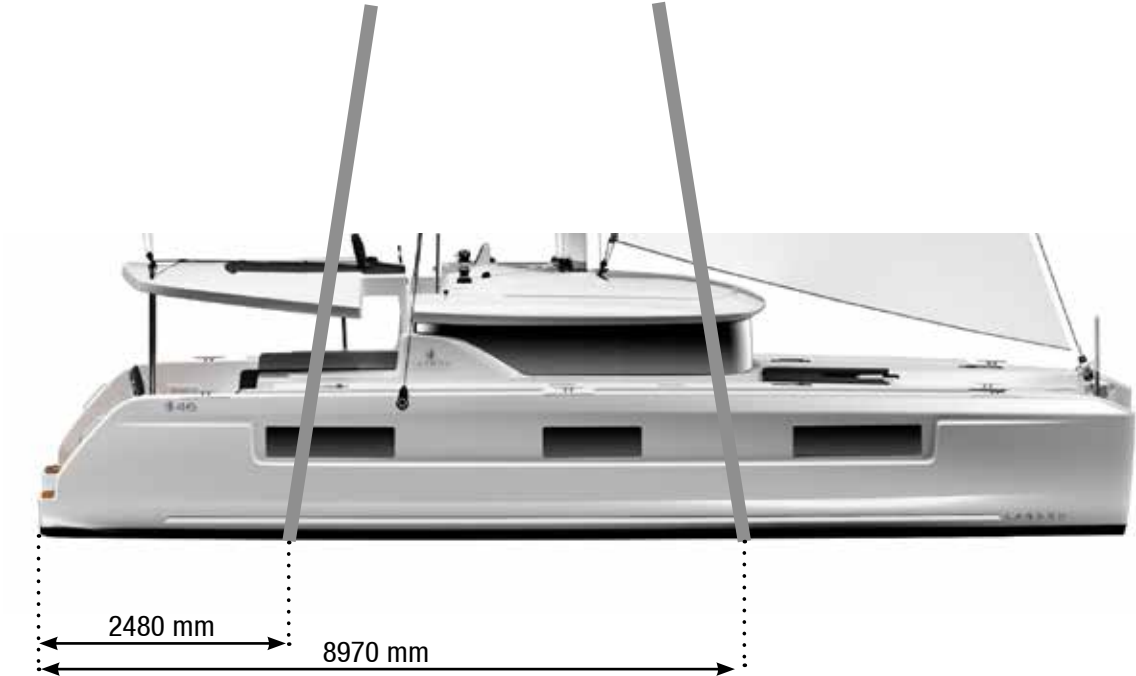

■ 10.1 Preparation

The initial launching and the first tests of the different equipments shall be carried out by your dealer so that you can expect to enjoy the warranty in case of some equipment failure.

All further handling shall be carried out with the highest care by professionals.

If the LAGOON boatyard are not involved in your handling operations, they cannot cover under guarantee any possible accidents linked to handling.

If later you have to launch your boat yourself, you should take the following precautions:

- Retract the sensors under the hull into their housings (they may be damaged by the handling slings).
- Check the water suction boxes for cleanliness.
- Turn off all the water inlet and drain valves (grey waters, black waters, engines).
- Check the anodes are in good condition and properly installed. An anode shall never be painted.

■ 10.2 Crane lifting

- Install a bow mooring rope, a stern mooring rope and fenders.
- When using a crane to move the boat, check that slings cannot touch any device (depth finder, speedometer, etc.) nor the propellers.

The crane hook will be fitted with a gantry or a spreader system with two slings.

The slings shall not be connected directly onto the hook, as it would result in unusual compressive stresses on the hull.

- Crane lifting should be carried out slowly.
- Control the movement of the boat using mooring ropes.

DANGER

Do not stay on board or under the boat during craning.

■ 10.3 Mast stepping - Mast unstepping

Mast stepping and mast unstepping shall be carried out by a specialist.

SAFETY

11

- 11.1 Prevention**
- 11.2 Gas system**
- 11.3 Fire**
- 11.4 Bilge pump system**
- 11.5 Safety equipment**
- 11.6 General remarks**

SAFETY

102

■ 11.1 Prevention

• THE CREW

For your own safety and your crew's, you shall respect some basic principles:

- Before you sail, check the different components of your safety equipment, their location and their expiry dates.
- Check the location and validity of the official documents as well.
- Tell the crew where the safety equipment is, how it works and the elementary safety procedures to follow.

When sailing, always be able to indicate your precise position.

In case an incident on board should happen and help be asked, this will be the very first question you will be asked.

RECOMMENDATION

Equip the children (and depending on the weather, the whole crew as well) with life jackets or harnesses.

WARNING

Do not exceed the number of persons indicated in Chapter 'SPECIFICATIONS'.

If you do not take the number of persons into account, the combined weight of the persons and equipment should never exceed the maximum load recommended by the builder.

• THE BOAT

For the sake of prevention and to be able to feel confident to face successfully the possible dangers on board (fire, leak), learn to recognize and locate the different elements which might be the cause of these disorders and the equipments to cope with them as well.

Risk of fire:

- Electrical system (chapter 7)
- Engines (chapter 8)
- Gas system (chapter 11)

Risk of leak:

- Water systems (chapter 6)

RECOMMENDATION

In emergency situation, it is essential to be able to locate quickly all the appropriate safety equipments.

GAS SYSTEM

SAFETY

104

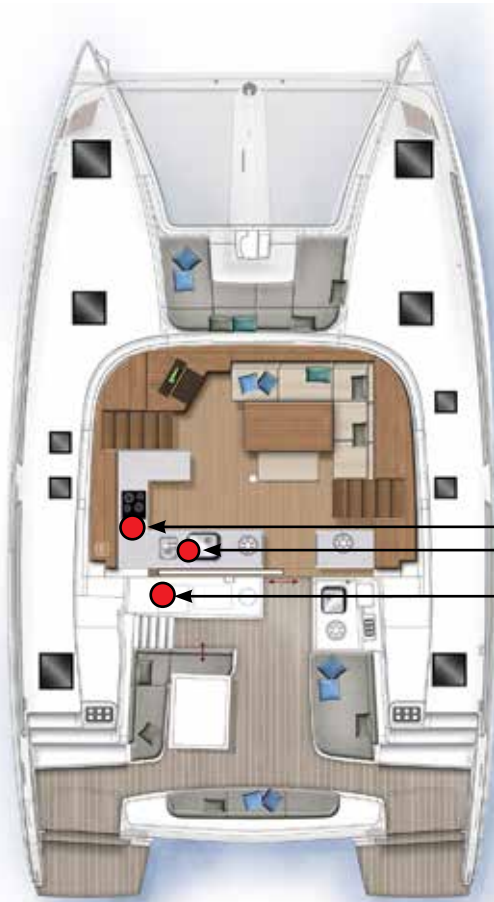

1
2
3

GAS VALVES



- 1 - Gas valves.
- 2 - Electrovalve switch (version U.S.).
- 3A - Locker / storage space of gas bottles.

ELECTROVALVE SWITCH (US VERSION)



- 3B - BubbleLeak Detector.
- 3C - Electrovalve (U.S. version).
- 3D - Leakdetection gauge (version U.S.).

BUBBLELEAK DETECTOR



LEAKDETECTION GAUGE (US VERSION)



■ 11.2 Gas system

The cockpit forward locker is designed to hold the gas bottle (13 kg). The circuits opening / closing valves are located in the cupboard under the hotplates.

The boat in her U.S. version has an electrovalve located in the locker where the bottle is stored.

Operate the electrovalve via its switch in the cabinet under the sink.

RECOMMENDATION

Close the gas valve and turn off the regulator tap when the stove and oven are not used.

• GAS LEAK DETECTION

The gas circuit is equipped with a leak detection system.

Standard version: a bubble leak detector is placed on the circuit after the regulator in the cylinder storage container.

When the cylinder is open (system pressurised) and the valve under the gas appliance is closed, press the red button on the detector.

If nothing happens, the circuit is sealed.

The appearance of bubbles in the detector liquid signals a leak on the gas circuit.

US version: a pressure gauge is placed on the circuit after the regulator in the cylinder storage container.

When the cylinder is open (system pressurised) and the valve under the appliance is closed, the pressure on the manometer must remain constant.

If the pressure drops then this means that there is a leak on the gas circuit.

DANGER

In case of a leak, turn off the gas circuit immediately.
Call a professional immediately to repair gas system.

■ 11.3 Fire

The boat is delivered with no extinguisher.

Be sure:

- To fit the boat with extinguishers in pursuance of the regulations of the country where your boat is registered.
- To have the extinguishers checked in accordance with the instructions given.
- To refill or replace the extinguishers by similar equipment if the extinguishers have been used or are out of date.
- Make sure the extinguishers are accessible when people are on board.

Tell the crew:

- where the extinguishers are and how they work.
- where the extinguisher hole in the engine bay is (under the aft cabins berths, both on the port and starboard sides).
- where the emergency exits are.

INSIDE SAFETY EQUIPMENTS

SAFETY

106

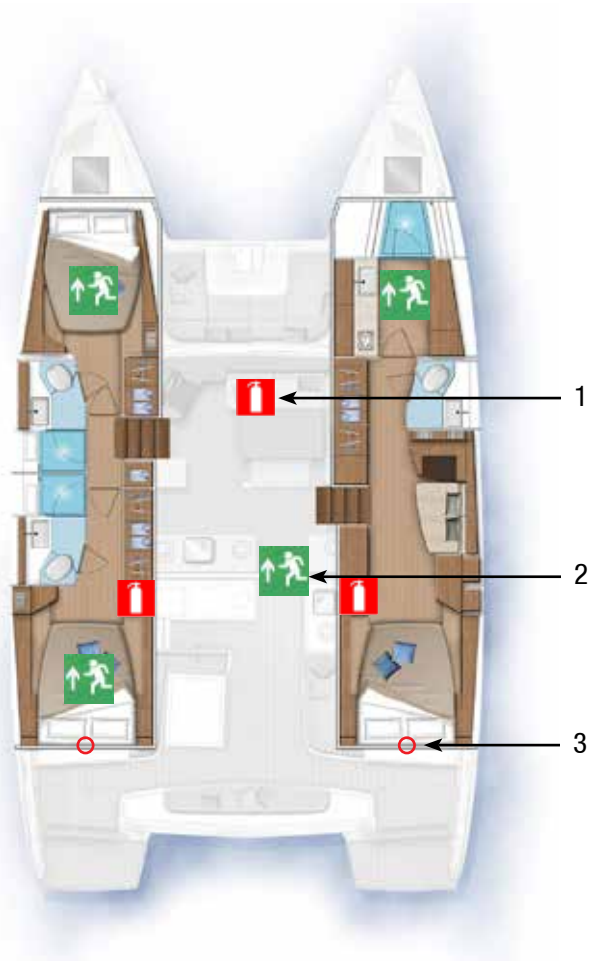

Please note: you can find the same locations in the other accommodation version.

- 1 - Extinguisher.
- 2 - Emergency exit.
- 3 - Extinguisher vent.
- 4 - Distress flares.
- 5 - First aid kit.
- 6 - VHF (optional extra).
- 7 -
- 8 -
- 9 -
- 10 -
- 11 -
- 12 -
- 13 -
- 14 -
- 15 -

RECOMMENDATION
 Some components do not have a pre-determined place for them.
 Fill-in this drawing according to your own boat safety equipments.

- **ESSENTIAL PRUDENCE RULES**

Never:

- Obstruct access to the emergency exits.
- Obstruct safety controls (fuel valves, gas valves, power switches).
- Obstruct the access to the extinguishers placed in cupboards or lockers.
- Leave the boat unattended when a stove or heater is in use.
- Use gas lamps in the boat.
- Alter any of the boat's systems (electricity, gas or fuel).
- Fill up a tank when an engine is running or a stove or heater is on.
- Smoke while handling fuels.

Make sure that engine bays are clean at all times and regularly check that there are no fumes or fuel and gas leaks.

Do not store flammable products in the engine holds.

WARNING

Should you replace components of the fire extinction system, only proper components with the same designation or with equivalent technical capacities and fire resistance should be used.

DANGER

Use CO2 extinguishers only to fight electrical fires. Evacuate the area immediately after discharging the product to prevent asphyxia. Ventilate before entering.

- **PROCEDURE TO FOLLOW IN THE EVENT OF FIRE**

- Turn off the engines if operating.
- Cut off the power supply, the fuel supply.
- Cut off all sources of air (smother the fire using blankets).
- Hold the extinguisher upright and aim at the heart of the fire.

If fire broke out in an engine hold:

- Turn off the engines if operating.
- Cut off the power supply, the fuel supply and gas supply if required.
- Shut off the air supply using towels to block off the engine air inlets, intakes and outlets.
- Cast the extinguisher product using the extinguisher vent located at the back of the aft cabins berths.
- Make sure that the fire is completely under control.
- Open the bay access hatch to make any necessary repair.

DANGER

Always keep an extinguisher handy in case the fire should start again.

OUTSIDE SAFETY EQUIPMENTS

SAFETY

108



- 1 - Crank location.
- 2 - Manual bilge pumps.
- 3A - Location of the life raft.
- 3B - Location of the life raft. (option tenderlift).
- 4 - Extinguishers.
- 5 - Life buoy location.
- 6 -
- 7 -
- 8 -
- 9 -
- 10 -
- 11 -
- 12 -
- 13 -
- 14 -
- 15 -

RECOMMENDATION
 Some elements do not have a pre-determined location for them.
 Fill-in this drawing according to your own safety equipments.

MANUAL BILGE PUMP



CRANK LOCATION



LIFERAFT LOCATION



■ 11.4 Bilge pump system

- BILGE PUMPS

The boat is fitted with two bilge pumps in each hull:

- an electric pump automatic release located in the well.
- a manual cockpit pump.

For further information, please refer to Chapter 'WATER SYSTEMS'.

- MANUAL BILGE PUMPS

In case of failure or if the electric bilge pumps are not enough, you can use the manual bilge pumps with cranks (stored in the cockpit aft locker).

- PROCEDURE TO FOLLOW IN THE EVENT OF A LEAK

Make sure that the electric bilge pumps are switched on.

If it is not enough to overcome the water level, ask a crew man to use a manual pump.

■ 11.5 Safety equipment

Before you sail, list the compulsory safety equipments.

Do not exceed the number of persons indicated in Chapter 'SPECIFICATIONS'.

WARNING

The list of the compulsory safety equipments corresponds to a certification category, a design category as well as to the regulations in the country where the boat is registered.

- LIFE RAFT

The liferaft storage location is at the stern of the boat.

Fit your boat with a life raft in pursuance of the regulations of the country where the boat is registered.

You shall use the life raft only if all else fails.

RECOMMENDATION

Before you sail to sea, carefully read the launching instructions on the life raft.

EMERGENCY TILLER - MAN HOLES

SAFETY

110

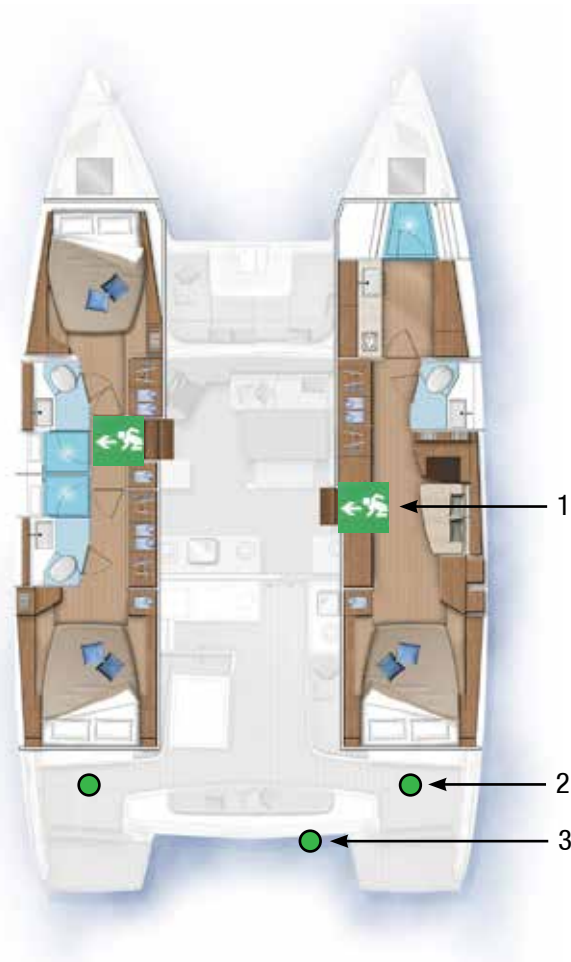

Please note: you can find the same locations in the other accommodation version.

MANHOLE HATCH



- 1 - Man hole + emergency hammer.
- 2 - Emergency tiller cover
- 3 - Emergency hammer (option tenderlift).

EMERGENCY HAMMER



EMERGENCY TILLER COVER



EMERGENCY HAMMER OPTION TENDERLIFT



- **EMERGENCY TILLER**

The emergency tiller is stored in a locker.
It shall be kept easily accessible.

To operate the tiller:

- Use a winch handle and unscrew one of the tiller covers situated on one of the aft transom extensions.
- Insert the tiller into the rudder stock, making sure it is well fitted into the tiller head block.
- Unplug every device connected to the spindles of the rudders.

- **CAPSIZING**

Two "man holes" are provided in each hull passageways.

A hammer to break the glass is provided under a step in each float and the liferaft storage compartment.

A fourth hammer is delivered with an optional tenderlift.

The liferaft storage location is at the stern of the boat.

WARNING

Regularly check the safety equipments are in good working order.

Follow the service programme without fail.

Generally speaking, take particular care of all the safety equipment of your boat.

■ 11.6 General remarks

- **MANOEUVRES**

- Know where your crew members are and inform them before you manoeuvre on the boat.
- Carefully manoeuvre on the deck and always wear shoes.

- **ENGINES**

- Systematically stop the engines before you dive or swim next to the boat.
- Never try to free a fishing net or a piece of rope that is caught on a propeller when the latter is rotating.

- **TOWING**

If you have to tow another boat, tow her at a reduced speed and as smoothly as you can.
Be particularly careful when throwing or catching the towing line (It may catch on the propellers).

MAINTENANCE

12

12.1 Maintenance schedule

■ **12.1 Maintenance schedule**

The information given hereafter are only examples and it is not an exhaustive list.

They must be adapted, depending on the use of your boat.

WARNING
 Follow without fail the recommendations given in the instruction guides by the manufacturers of the components added to your boat.

HULL / DECK FITTING / HULL

- Clean the hull with appropriate products QUATERLY
- Clean s/s parts..... QUATERLY
- Dismount, clean and grease winches..... ANNUAL
- Check the watertightness of the sea-cock fittings..... BI-ANNUAL
- Clean the sea cock fittings and strainers from the outside BI-ANNUAL

MOORING / WINDLASS

- Rinse ground tackle and anchor locker with fresh water WHEN USED
- Check the gypsy and anchor/chain fastening deviceBI-ANNUAL
- Check windlass brake system QUATERLY
- Check mooring lines and fenders.....BI- ANNUAL
- Check the electric connections (remote control, relay, etc.).....QUATERLY

RUNNING / STANDING RIGGING / SAILS

- Lubricate the different travellers with teflon QUATERLY
- Check and tighten the different shackles QUATERLY
- Check the running rigging tightening QUATERLY
- Check the halyard and sheet for wear points QUATERLY
- Rinse the whole running rigging and sailsQUATERLY
- Check the mainsail battens and main seamsQUATERLY

MAINTENANCE

UPHOLSTERY AND COVERS

Rinse / clean the different covers QUATERLY
Dry the outside upholstery before its storage WHEN USED

REFRIGERATION UNIT

Defrost the refrigerators and freezerQUATERLY
Check the door jointsQUATERLY

AIR CONDITIONING

Check the sea cock and clean / change the different
sea water filtersQUATERLY
Dust off the unit heater fans ANNUAL

ELECTRICITY

Check and tighten the battery terminal connections
and main switch connections.....BI-ANNUAL
Check and tighten the main relay terminals
(winches, windlass, etc.).....BI-ANNUAL

ENGINES AND GENERATOR

Check oil levelQUATERLY
Check belt tensionQUATERLY
Clean the sea water strainerQUATERLY
Check for leaks (oil, water, fuel) and smokesQUATERLY
Check and drain the decanter filters (fuel)QUATERLY
General overhaul.....REFER TO THE ENGINE MANUFACTURER'S GUIDE

WATERMAKER

Check and clean the sea water suction strainers..... QUATERLY
General inspection by the manufacturer..... ANNUAL

PLUMBING

Check the automatic bilge pumps and alarms.....QUATERLY
Rinse the black water tanksQUATERLY
Check the manual bilge pumps.....QUATERLY
Check the pressure water pumpQUATERLY
Check the different drains and scuppersQUATERLY
Open and close the different valves on board
+ grease if necessary BI-ANNUAL

12

MAINTENANCE

115

